

# Table of Contents

<b>Chapter 1 Safety Instructions</b> .....	1
1.1 Use instruction .....	1
1.2 Safety instruction of UPS .....	1
1.3 Safety instruction of battery .....	2
1.4 Description of common symbols .....	3
<b>Chapter 2 Product Description</b> .....	4
2.1 Product description .....	4
2.2 Model description .....	4
2.3 Operating principle .....	4
2.3.1 Functional block diagram .....	4
2.3.2 Operating mode .....	5
2.4 System structure .....	7
2.4.1 Product appearance .....	7
2.4.2 Product structure .....	9
2.4.3 Structure of system control module .....	13
2.5 Optional accessories .....	14
<b>Chapter 3 Monitoring Display Interface</b> .....	15
3.1 Description of monitoring display unit .....	15
3.1.1 Appearance of panel .....	15
3.1.2 LCD and indicator light .....	15
3.2 Description of monitoring display interface .....	16
3.2.1 General .....	16
3.2.2 Home page .....	17
3.2.3 System .....	18
3.2.5 Control .....	29
3.2.6 Setting .....	32
<b>Chapter 4 Operation Instructions</b> .....	48
4.1 Operation of single UPS .....	48
4.1.1 Power on UPS .....	48
4.1.2 Power off UPS .....	50
4.1.3 Cold starting of battery .....	51
4.1.4 Manual switching to bypass power supply .....	51
4.1.5 Switching to maintenance bypass .....	52
4.1.6 Change from maintenance bypass power supply to inverter power supply .....	52
4.1.7 Emergency shutdown (EPO) .....	53
4.1.8 Recovery after emergency shutdown .....	53
4.1.9 Firmware upgrade .....	54

---

<b>4.2 Parallel operation</b> .....	55
<b>4.2.1 Start parallel system</b> .....	55
<b>4.2.2 Power off parallel system</b> .....	58
<b>4.2.3 Emergency shutdown (EPO)</b> .....	58
<b>4.2.4 Quit maintenance of single UPS</b> .....	58
<b>4.2.5 Addition of single UPS after maintenance</b> .....	58
<b>Chapter 5 UPS Maintenance</b> .....	60
<b>5.1 UPS Maintenance</b> .....	60
<b>5.1.1 Monthly maintenance</b> .....	60
<b>5.1.2 Quarterly maintenance</b> .....	60
<b>5.1.3 Yearly maintenance</b> .....	61
<b>5.2 Battery maintenance</b> .....	61
<b>Chapter 6 Failure Removal</b> .....	62
<b>Chapter 7 Technical Parameters</b> .....	63
<b>Appendix 1 Display Menus</b> .....	65
<b>Appendix 2 List of Alarms</b> .....	72
<b>Appendix 3 Abbreviation</b> .....	83

# Chapter 1 Safety Instructions

## 1.1 Use instruction

- Before installing and using the product, please read the "Safety Instructions" carefully to ensure correct and safe installation and use. Please keep this manual properly.
- The UPS must be installed, debugged and maintained by the engineers authorized by the manufacturer or its agent, otherwise it is possible to endanger personal safety and cause equipment failure. The damage caused to the UPS hereon is not covered by the warranty.
- Under no circumstances shall the structure or components of the equipment be dismantled or altered without the manufacturer's approval, otherwise the damage caused hereon to the UPS is not covered by the warranty.
- During using the equipment, comply with local laws and regulations. The safety instructions provided in this manual are only a supplement to local safety codes.
- The content of this document may be updated from time to time without prior notice due to product version upgrade or other reasons. Unless otherwise specified, this document is only used as a use guidance, and all statements, information and recommendations contained in this document do not constitute any warranty, express or implied.

## 1.2 Safety instruction of UPS

- Before installing the equipment, wear insulating protective clothing and insulating appliances, and remove conductive objects such as jewelry and watches to avoid electric shock or burns.
- The operating environment has a certain impact on the service life and reliability of UPS. The equipment must be used and stored in accordance with the environmental requirements set in the manual.
- Do not use the equipment in the environment with direct sunlight, rain or electrically charged dust.
- When the UPS is installed, a safe distance should be left around it to ensure ventilation. During the operation of the system, do not block the vent.
- Liquids or other foreign objects are not allowed to enter the UPS cabinet or chassis.
- Before using UPS, check whether the local power characteristics are consistent with the information provided in the product nameplate.
- As the UPS is a large leakage current equipment, it is not recommended to use the air switch with the leakage protection function.
- Before the wiring of the UPS, further confirm whether the switch connecting the UPS main input power/bypass power supply to the mains power distribution is disconnected.
- If it is required to move or rewire the UPS, the AC input power supply and the battery input must be disconnected, and the corresponding operation should be carried out only after the UPS is completely powered down (more than 5min), otherwise the port and interior of the equipment may have current, it is possible cause a risk of electric shock.





- Before powering on, please make sure that the UPS is grounded properly, and check the cable connection and battery polarity to make sure it is correct. In order to ensure personal safety and normal use of the UPS, the UPS shall be reliably grounded before use.
- UPS can be used for resistive and capacitive (such as computers), resistive and micro-inductive loads, not for pure capacitive, pure sensitive loads (such as motors, air conditioners and photocopiers, etc.) and half wave rectifier loads.
- During cleaning, please use a dry cloth to wipe the machine. Under no circumstances is water allowed to clean the internal and external electrical parts of the cabinet.
- Immediately after the maintenance operation, check to ensure that no tools or other items have been left in the cabinet.
- In case of fire, use a dry powder extinguisher to extinguish the fire. The risk of electric shock may be caused if a liquid fire extinguisher is used.
- Do not disconnect the switch until the UPS installation is complete. Please do not power up the UPS without the permission of an authorized engineer.

### 1.3 Safety instruction of battery

- The battery should only be installed and maintained by the personnel with battery expertise.
- There is danger of electric shock and short circuit current in the battery. In order to avoid safety accidents, during installing or replacing batteries, please pay attention to the following matters: do not wear jewelry, watches and other conductive objects; use special insulating tools and facial protective devices; wear insulated protective clothing; do not place the battery upside down or tilt it; battery input switch should be kept disconnected.
- Install the battery in the environment far away from the heating area, do not use or keep the battery near the fire source, do not use fire to deal with the battery or battery pack, otherwise it is possible to cause explosion and personal injury.
- The battery life decreases with the increase of ambient temperature. The battery should be installed and stored in a cool, dry environment.
- Regular battery replacement can ensure the normal operation of the UPS, and adequate backup time.
- Check the bolts of the battery connecting screws regularly to make sure they are tightened and not loose. If loose, the screws must be tightened immediately.
- Do not make short circuit for the positive and negative electrode of the battery, otherwise it is possible to cause electric shock or fire.
- Do not touch the connecting terminal of the battery. If the battery circuit is not isolated from the input voltage circuit, and there is a high voltage hazard between the battery terminals and the ground.
- Do not open or damage the battery, otherwise it is possible to cause short circuit and electrolyte leakage. The electrolyte in the battery may cause damage to the skin and eyes. In case of accidental exposure to the electrolyte, immediately clean with a lot of water and go to the hospital for examination.

## 1.4 Description of common symbols

The following symbols are used in this manual, and have the following meanings.

Symbol	Description
 Danger	It is used to indicate urgent and dangerous situations that, if not avoided, may result in death or serious bodily injury.
 Warning	It is used to to indicate potentially dangerous situations that, if not avoided, may result in some degree of personal injury.
 Attention	It used to indicate equipment or environmental safety warning, if not avoided, may lead to equipment damage, data loss, equipment performance degradation or other unpredictable results.
 Note	It is used to give further detail to what is being described, which highlights important/key information, etc.

## Chapter 2 Product Description

### 2.1 Product description

50kVA-600kVA products are a new generation of three-input and three-output high-end UPS designed and manufactured by latest research results and application experience. The advanced dual-core DSP digital control technology is used to effectively enhance product performance and system reliability, the idea of modular design is used to support the hot plugging of the power module, the bypass module, monitoring module and realize the integration of the higher power density and miniaturization. This series of products have excellent electrical performance, perfect software and hardware protection function, can adapt to different grid environment, can be used safe and reliable power supply for all kinds of loads.

### 2.2 Model description

The 50K modular UPS includes five system cabinets 200KVA, 300KVA, 400KVA, 500KVA and 600KVA. The power module is 50KW, which can adapt to the users' various power requirement. The UPS specification and model description are shown in Table 2-1.

Table 2-1 Model and specification of 50K modular UPS

Cabinet model	200kVA	300kVA	400kVA	500kVA	600kVA
Module quantity	4	6	8	10	12
Output power of single module	50kW	50kW	50kW	50kW	50kW

### 2.3 Operating principle

#### 2.3.1 Functional block diagram

Online double conversion design and DSP full digital control are used in 50KVA-600KVA series UPS to provide the users with high efficiency, high power density power supply. Its functional block diagram is shown in Fig. 2-1.

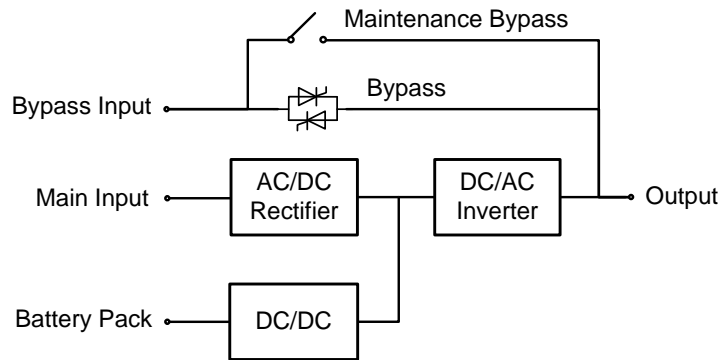

Fig. 2-1 Functional block diagram

### 2.3.2 Operating mode

#### Mains mode

The mains mode is the normal operation mode of UPS. Its main working process is as follows: the input voltage of the mains is rectified by the rectifying circuit, and then boosted by the booster circuit. One part of the input voltage is used to charge the battery through the DC/DC charger, and the other part is inverted by the inverter to output AC voltage to supply continuous and uninterrupted high quality AC power for the load. The operating principle of the mains mode is shown in Fig. 2-2.

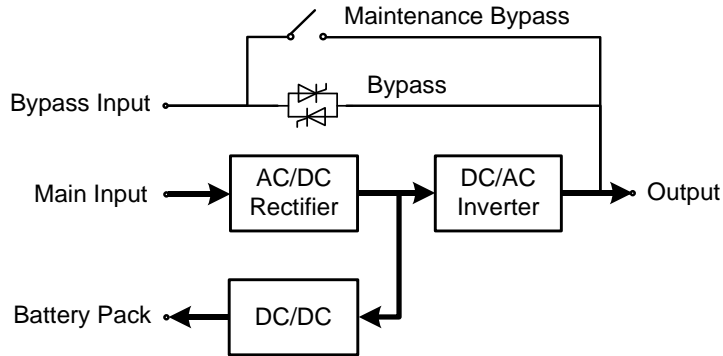

Fig. 2-2 Operating principle of mains mode

#### Bypass mode

In case of inverter failure, inverter overload, or manual switching to the bypass, and other faults or operations, the UPS output is switched from the inverter side to the bypass side, and the bypass power supply will directly supply the power to the load. The power supply quality of the load is not protected by UPS in the bypass mode, and it is possible to cause power failure if the bypass input is abnormal. The operating principle of the bypass mode is shown in Fig. 2-3.

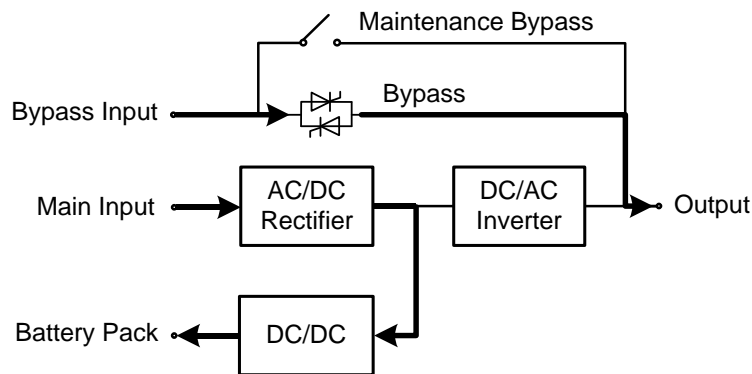

Fig. 2-3 Operating principle of bypass mode

#### Battery mode

In case of abnormal mains voltage, the UPS will automatically operate in the battery mode. In this case, the power unit obtains the power from the battery, the voltage is boosted through the booster circuit, and then AC voltage is output to the load through the inverter to supply the continuous and uninterrupted high quality AC power for the load. The operating principle of the battery mode is shown in Fig. 2-4.

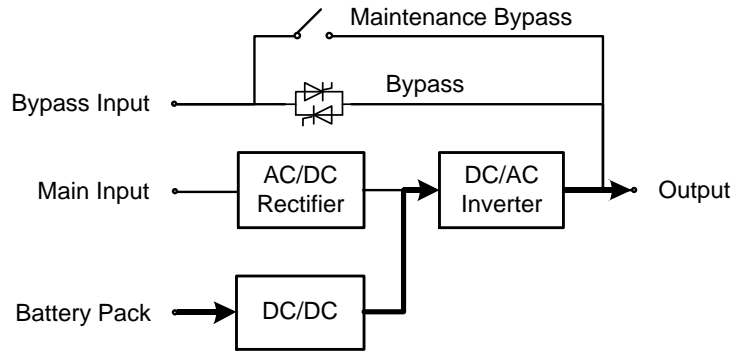

Fig. 2-4 Operating principle of battery mode

### ECO mode

ECO mode, the economic operation mode of the UPS, can be set through the LCD interface. In the ECO mode, when the bypass input voltage is within the ECO voltage range, the power is supplied by the bypass and the inverter is in standby state. When the bypass input voltage exceeds the ECO voltage range, the power will be supplied for the load by changing the bypass supply to the inverter. The rectifier is On and the battery is charged through the charger, whether the load is supplied by bypass or inverter. The ECO mode has higher system efficiency. The operating principle of the ECO mode works as shown in Figure 2-5.

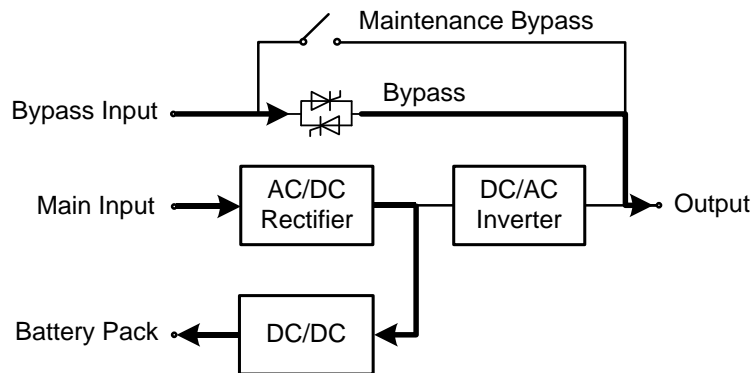

Fig. 2-5 Operating principle of ECO mode ECO

### Maintenance bypass mode

For maintenance and repair of UPS, the UPS is switched to operate in the bypass mode and the maintenance bypass switch shall be connected. When the UPS operates in maintenance bypass mode, the power is supplied through the maintenance bypass line, rather than the main power unit. In this case, the replaceable unit in the machine can be maintained. The operating principle of maintenance bypass mode is shown in Fig. 2-6.



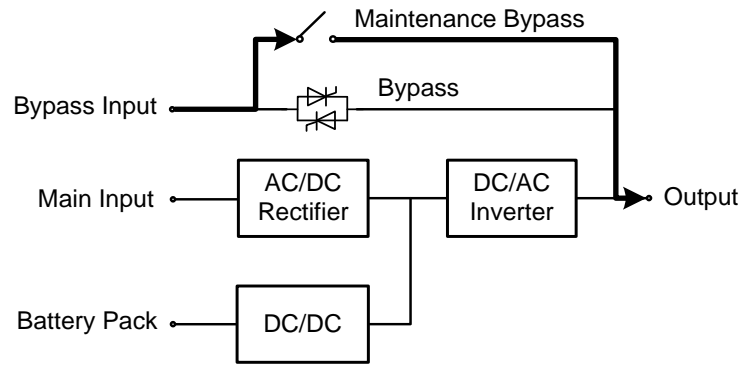

Fig. 2-6 Operating principle of maintenance bypass mode

## 2.4 System structure

### 2.4.1 Product appearance

200 kVA and 300kVA UPS have same appearance, as shown in Fig. 2-7.

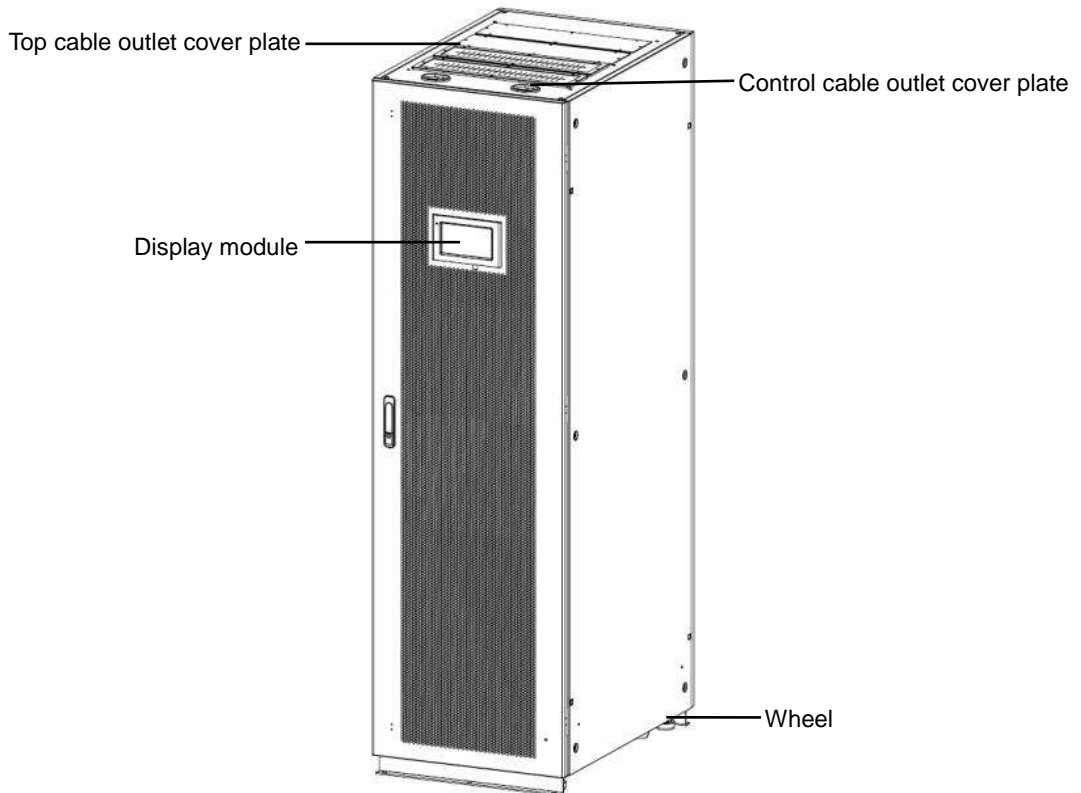

Fig. 2-7 Appearance of 200kVA and 300kVA UPS

The appearance of 400kVA/500kVA UPS is shown in Fig. 2-8.

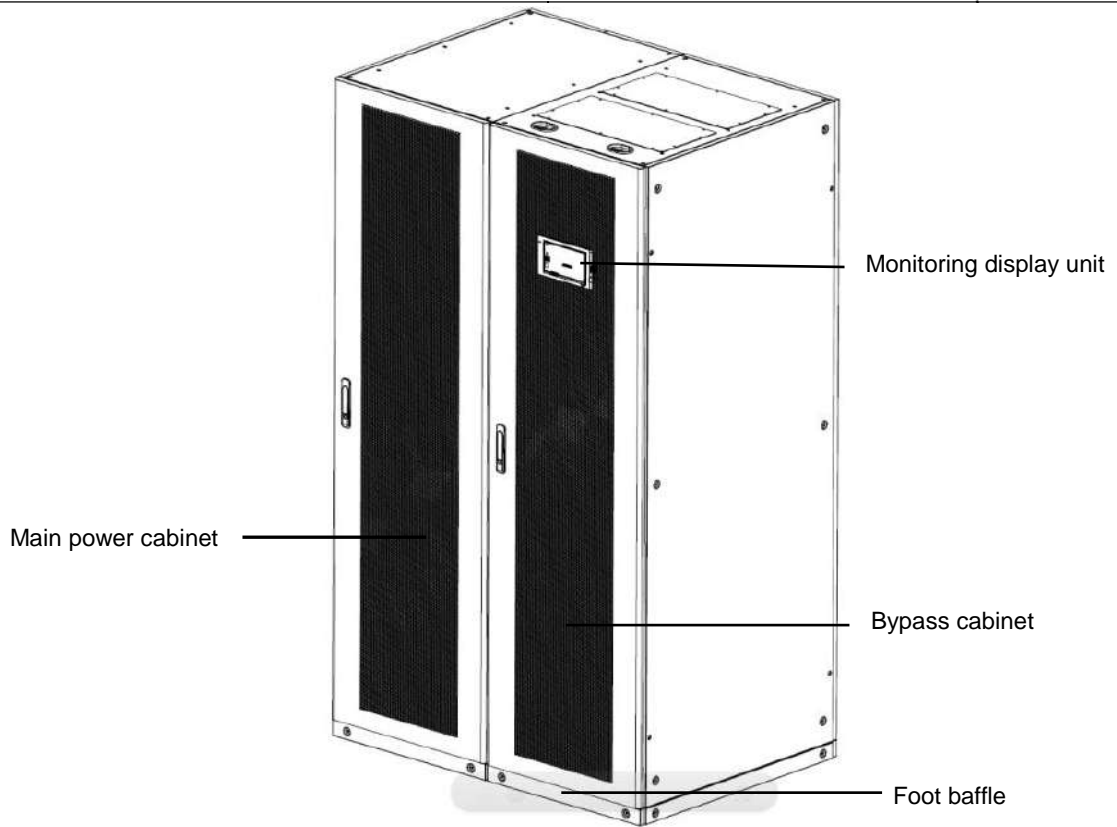

Fig. 2-8 Appearance of 400kVA and 500kVA UPS

The appearance of 600kVA UPS is shown in Fig. 2-9.

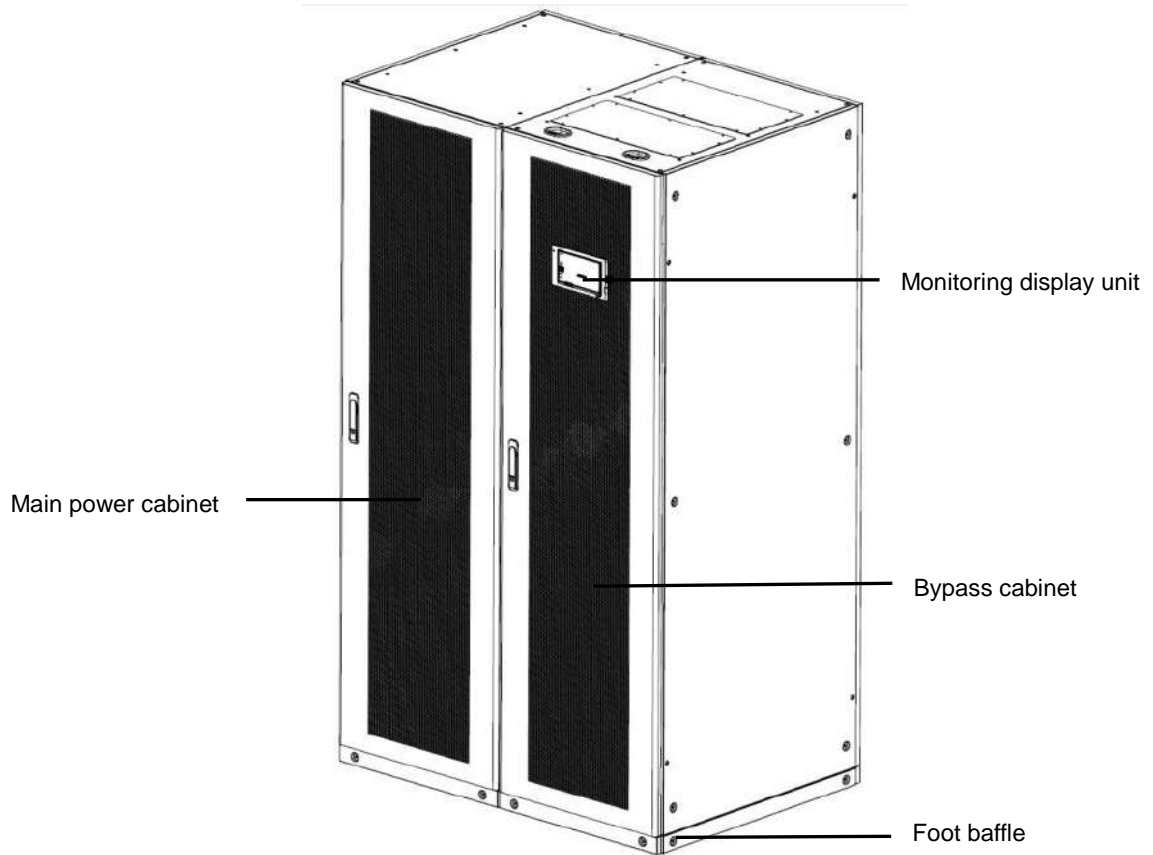

Fig. 2-9 Appearance of 600kVA UPS

### 2.4.2 Product structure

The structure of 200kVA UPS (standard) is shown in Fig. 2-10 in which the front door of the UPS is opened.

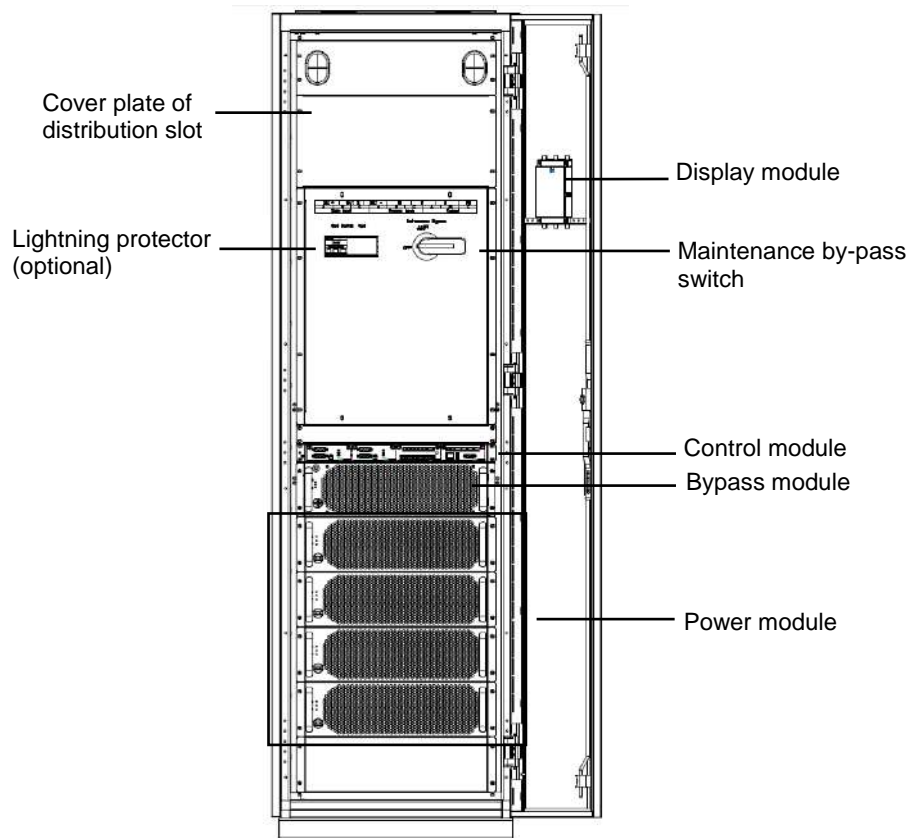

Fig. 2-10 Structure of 200Kva UPS (standard)

The structure of 200kVA UPS (full-load) is shown in Fig. 2-11 in which the front door of the UPS is opened.

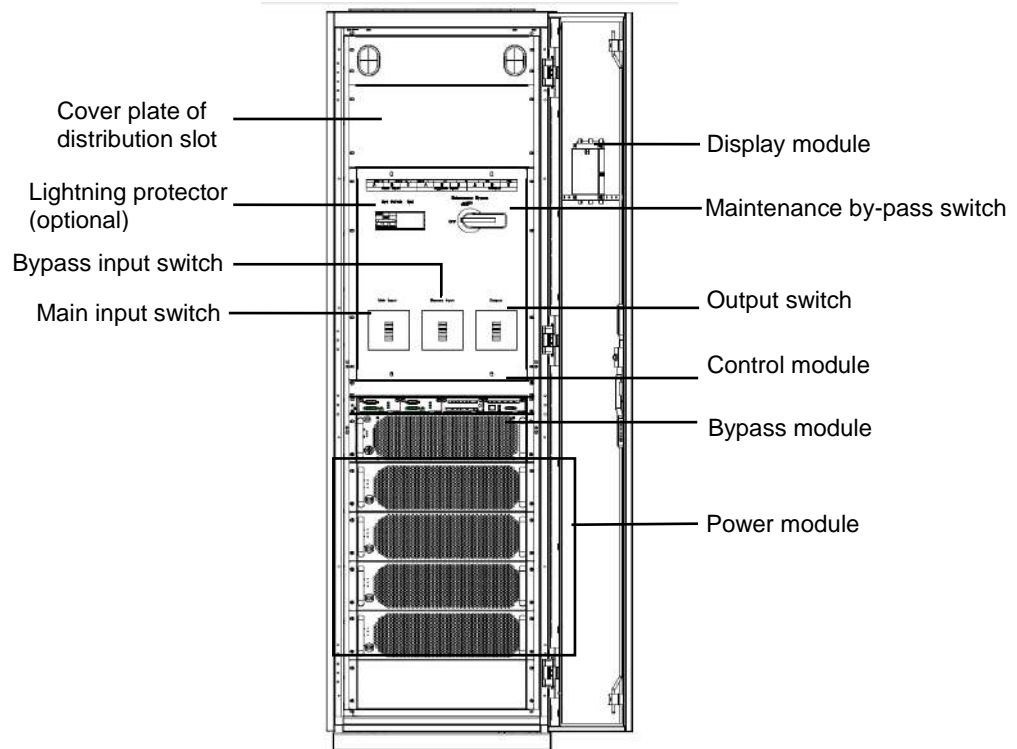

Fig. 2-11 Structure of 200kVA (full load)

The structure of 300kVA UPS (top cable inlet) is shown in Fig. 2-12 in which the front door of the UPS is opened.

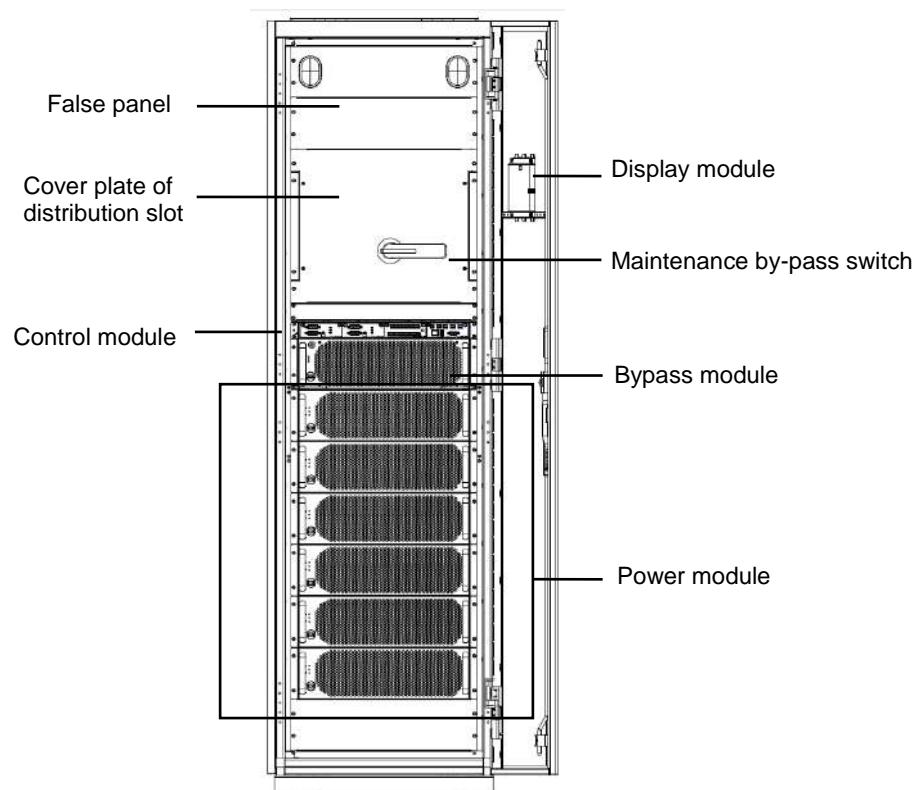

Fig. 2-12 Structure of 300kVA UPS (top cable inlet)

The structure of 300kVA UPS (bottom cable inlet) is shown in Fig. 2-13 in which the front door of the UPS is opened.

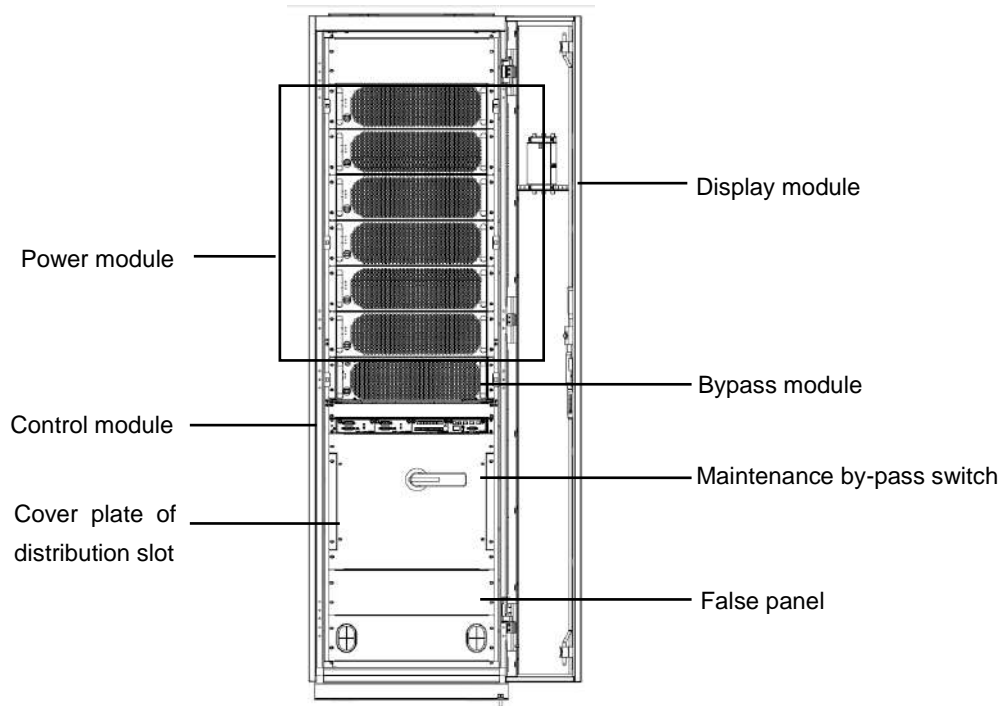

Fig. 2-13 Structure of 300kVA UPS (bottom cable inlet)

The full-load structure of 300kVA UPS is shown in Fig. 2-14 in which the front door of the UPS is opened.

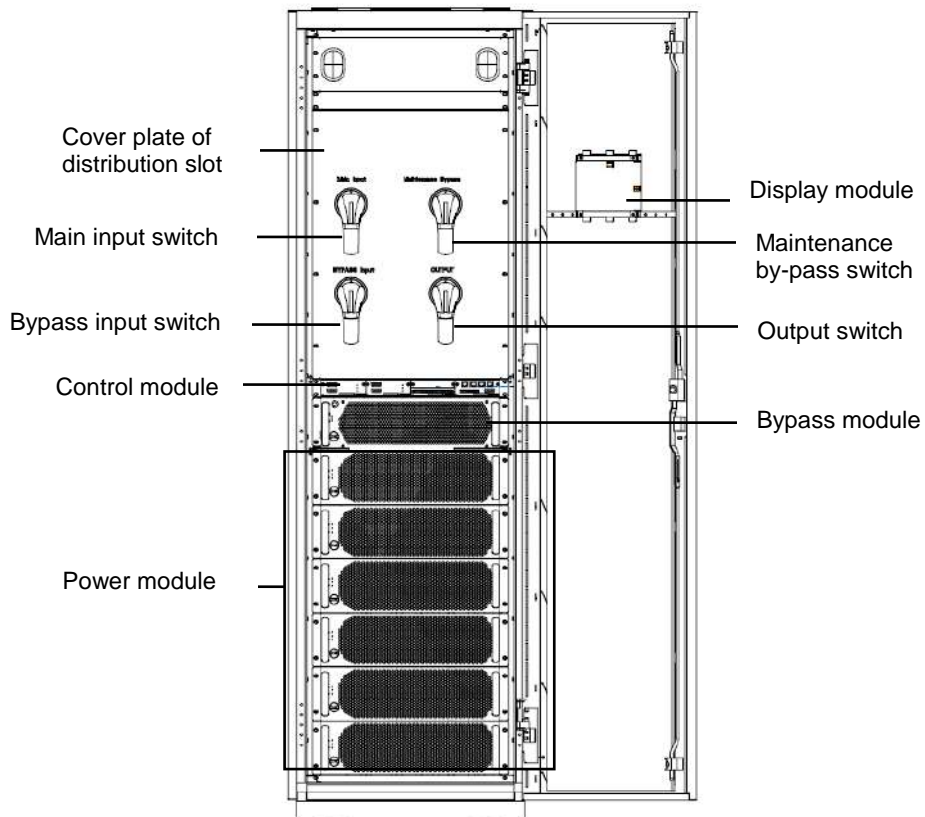

Fig. 2-14 Structure of 300kVA UPS (full load)

The full-load structure of 400kVA UPS is shown in Fig. 2-15 in which the front door of the UPS is opened.

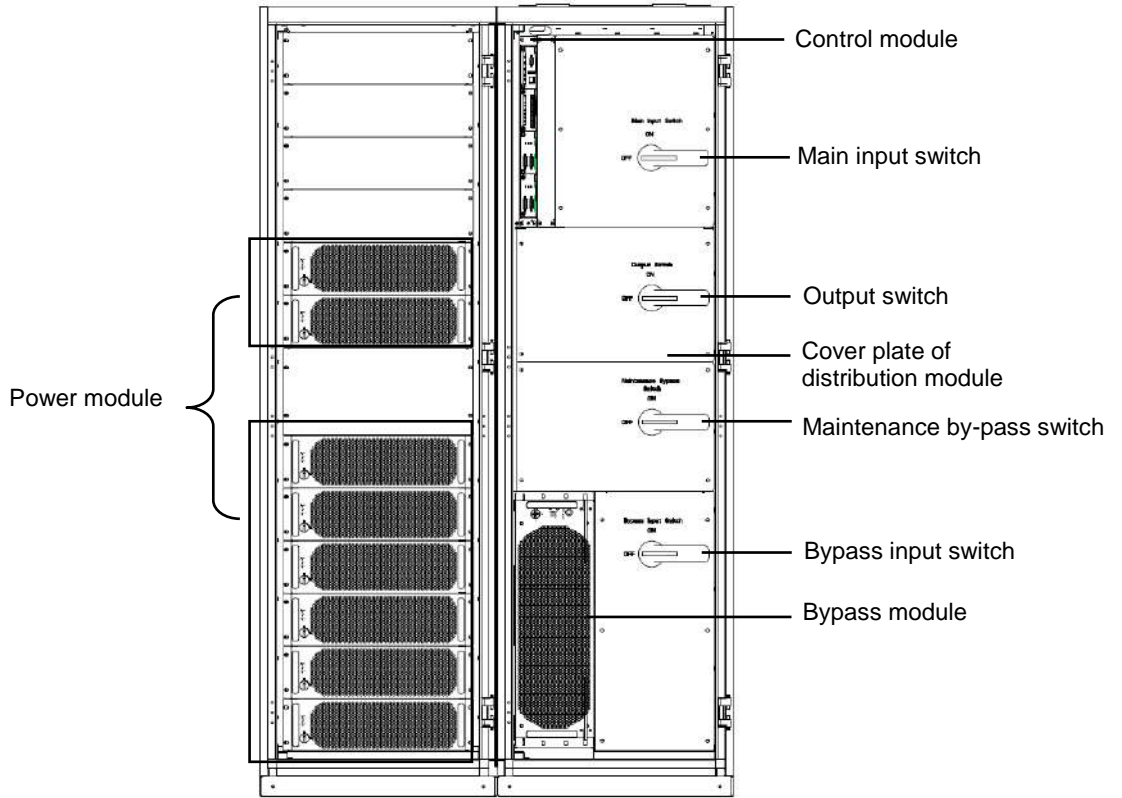

Fig. 2-15 Full-load structure of 400kVA UPS

The full-load structure of 500kVA UPS is shown in Fig. 2-16 in which the front door of the UPS is opened.

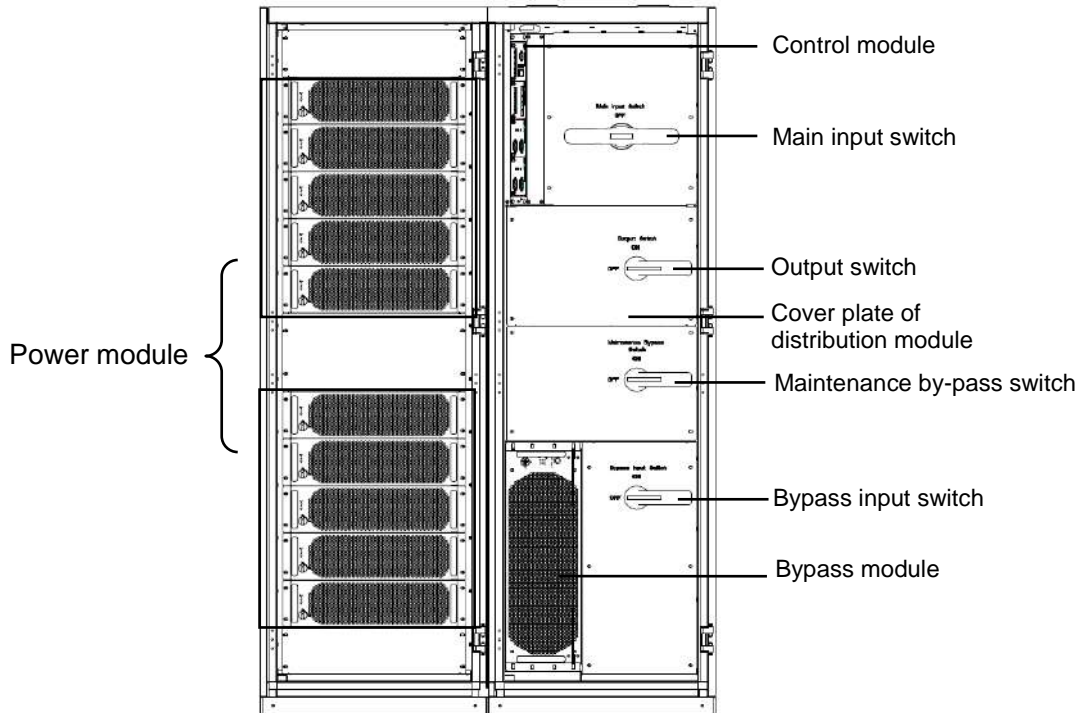

Fig. 2-16 Full-load structure of 500kVA UPS

The full-load structure of 600kVA UPS is shown in Fig. 2-17 in which the front door of the UPS is opened.

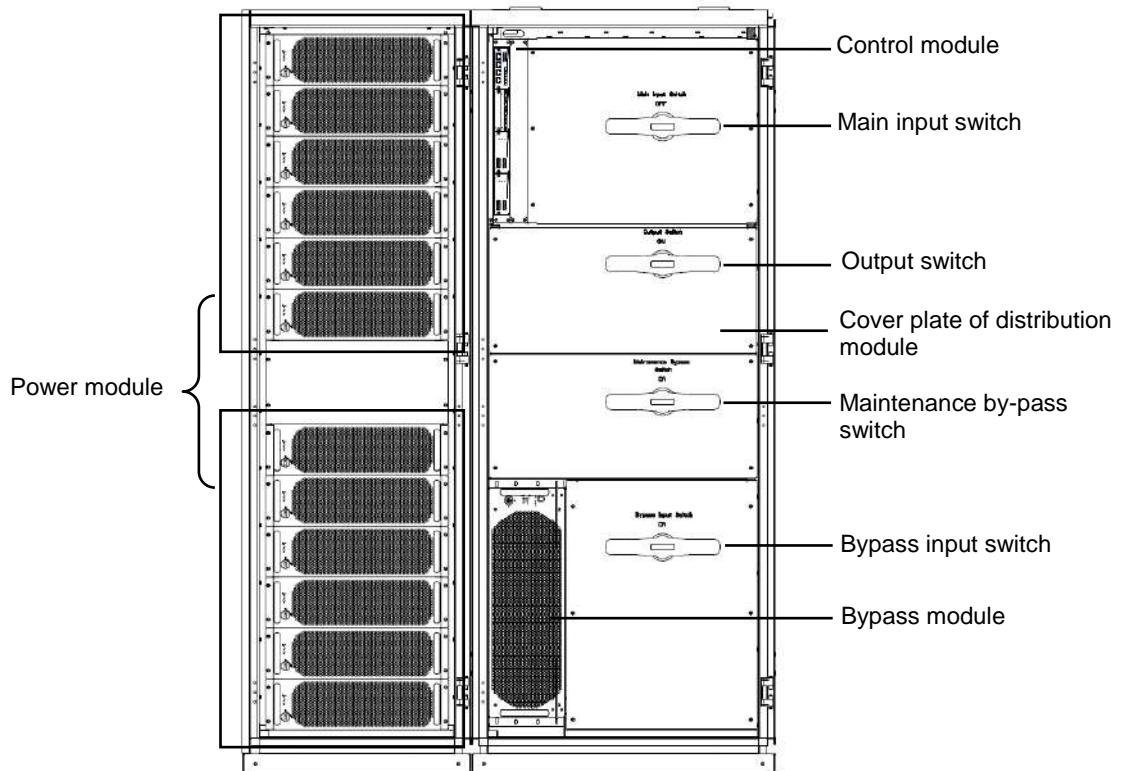

Fig. 2-17 Full-load structure of 600kVA UPS

### 2.4.3 Structure of system control module

The control modules of 50KVA-600KVAUPS system includes a system control board, a dry contact board and a monitoring board.

The interface of system control module is shown in Fig. 2-18.

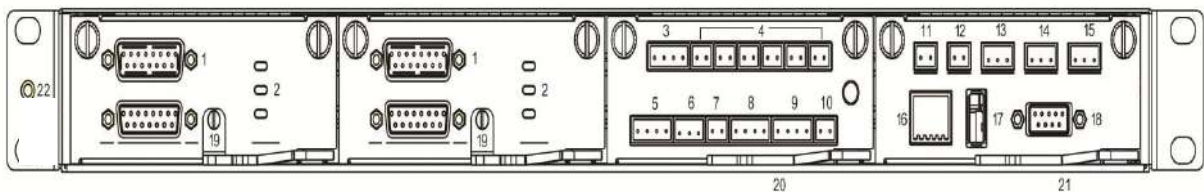

Fig. 2-18 Interface of system control module

Table 2-2 Control module signal panel

1	Parallel operation port	2	LED indicator light of system	3	Input dry contact
4	Output dry contact	5	Battery ground fault (BTG) interface/ generator (GEN) interface	6	Battery air switch (BCB) interface
7	Trip signal of battery air switch (BCB)	8	Emergency stop (EPO) interface	9	Status interface of distribution cabinet switch
10	Lightning protector	11	Ambient temperature interface	12	Battery temperature

	(SPD) interface				compensation interface
13	CAN interface	14	RS485 communication interface 1	15	RS485 communication interface 2
16	Ethernet (ETH) cable interface (ETH)	17	USB interface	18	LCD display interface
19	Plug switch of system board	20	Plug switch of dry contact board	21	Plug switch of monitoring board

Wiring diagram of 485 and CAN communication interface:

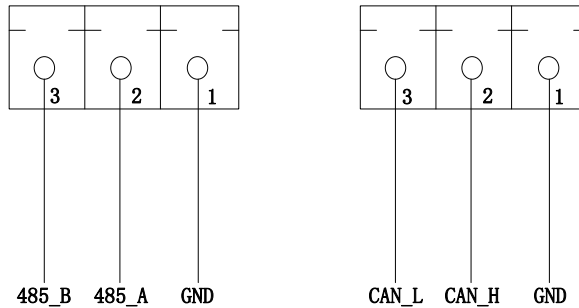

1.485 2.CAN

Fig. 2-19Wiring diagram of communication interface

## 2.5 Optional accessories

All optional accessories are provided for 50KVA-600KVA series UPS, as shown in Table 2-3, to meet the different configuration requirements of users.

Table 2-3 List of optional accessories for 50kVA-600kVAUPS

Optional accessories	Function
WIFI module	Functions, such as remote monitoring, operation status monitoring, emergency command issuance, system information reporting and so on, are performed by WIFI.
GPRS module	Functions, such as remote monitoring, operation status monitoring, emergency command issuance, system information reporting and so on, are performed by GPRS.
Battery inspection device	It is used to detect the voltage and temperature of each cell, and the discharge and charge current of the battery pack, and communicates with the upper computer by MODBUS communication protocol
Battery temperature sensor	It is used to detect the battery temperature, compensate the charge voltage according to the change in the ambient temperature, and extend the service life of the battery.
Parallel operation cable	It is used for connection of single UPS system for parallel operation.
LBS cable	It is used to transmit the bus synchronizing signal of the double bus system.



## Chapter 3 Monitoring Display Interface

### 3.1 Description of monitoring display unit

The monitoring display unit of the UPS is located on the front panel of the whole machine. The functions of UPS, such as operation control, parameter setting, operation status view, alarm view and other functions can be realized by the monitoring display unit.

Note: Note: the screenshot of the interface provided this document is taken from 400KVA, and the interface may vary with the program versions, the information provided in the menu picture is for reference only, and the specific parameters should be subject to the real object.

#### 3.1.1 Appearance of panel

The panel appearance is shown in Fig. 3-1.

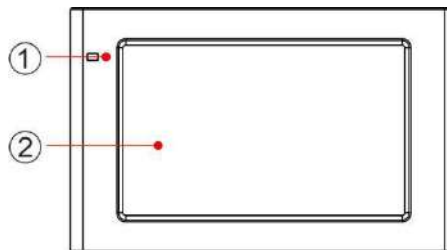

Fig. 3-1 schematic diagram of monitoring display unit

1	LED indicator light	2	LCD touch screen
---	---------------------	---	------------------

#### 3.1.2 LCD and indicator light

The monitoring display unit displays various operation information and alarm information of the UPS in real time through LCD, and the parameters of the UPS can be set and managed through the LCD. The status of the indicator light of the monitoring display unit is shown in Table 3-1.

Table 3-1 Status of indicator light

Indicator light	Color	Status	Meaning
Indicator light	Red	Lit	UPS failure
	Red	Flicker	UPS alarm
	Green	Lit	Power supply mode (mains mode, bypass mode, ECO mode, etc.)
	No	Off	Not started or standby

### 3.2 Description of monitoring display interface

#### 3.2.1 General

##### Menu structure

The menu structure of the monitoring display interface is shown in Fig. 3-2.

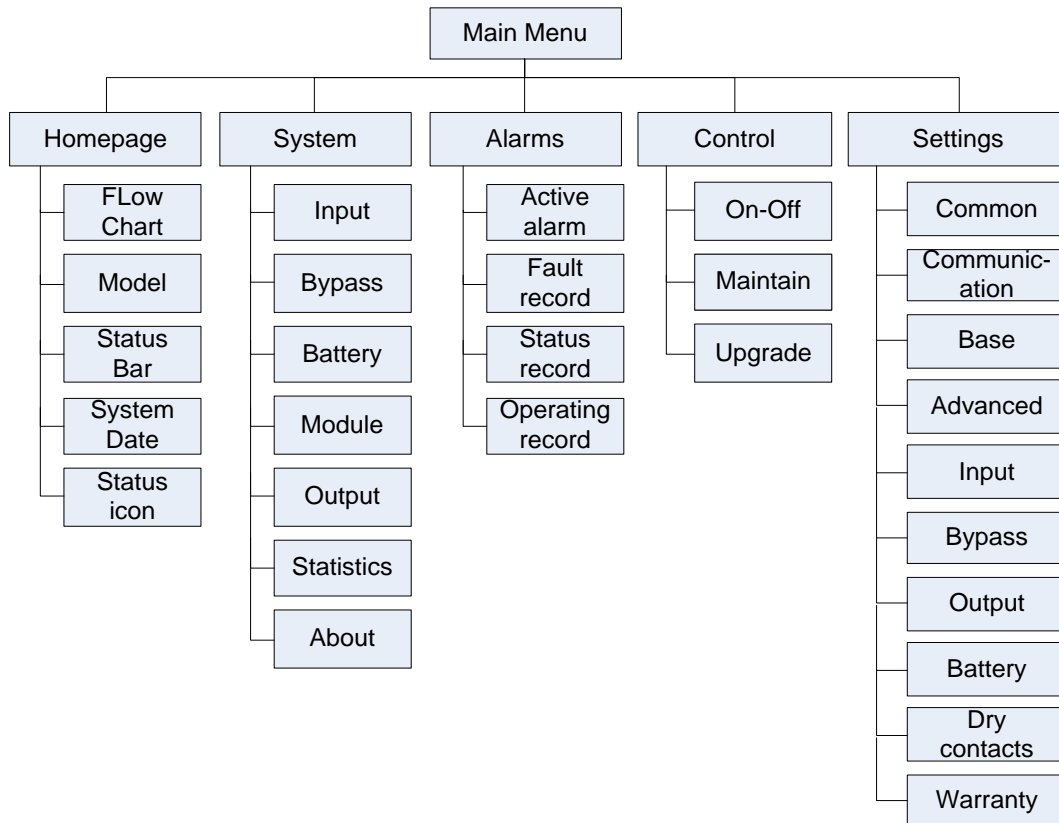

Fig. 3-2 Menu structure

##### Start for the first time

Quick setting can be carried out upon starting for the first time or restarting after factory settings are restored, as shown in Fig. 3-3. Specific quick setting interface includes language setting, display setting, system setting 1, system setting 2, the quick setting can be also skipped directly. Please refer to the "4.2.6 Settings" for the instructions and suggestions on settings.



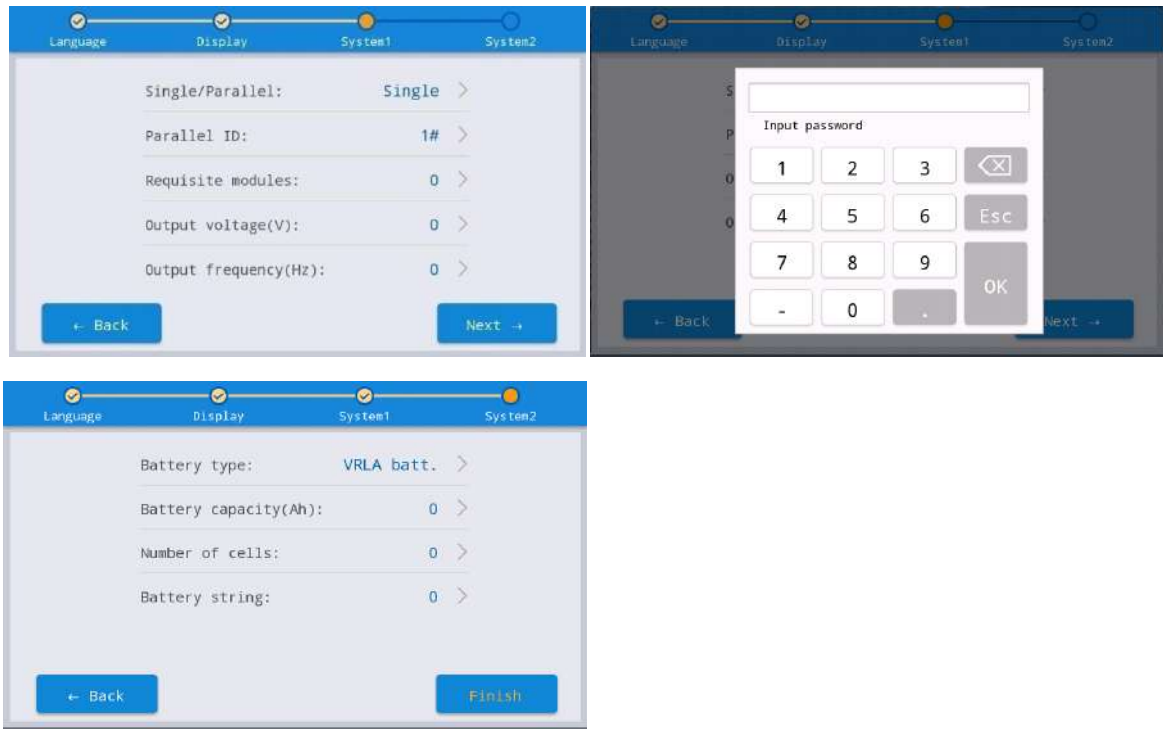

Fig. 3-3 Quick setting

After the quick setting is completed, enter the home page interface. The maintenance password is required for the system settings 1 and 2 in the quick setting.

### 3.2.2 Home page

The home page is divided into three parts: main menu, energy flow chart and status bar .The home page interface is shown in Fig. 3-4:

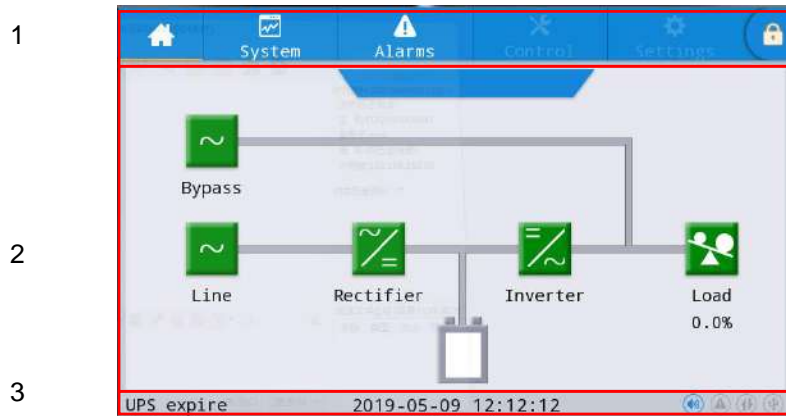

Fig. 3-4 Home page interface

Table 3-2 Function of interface areas

No.	Area	Function description
1	Main menu	Level 1 menu, including home page, system, alarm, control, setting, password login. Two menus, such as Control and Settings, are gray before login.
2	Energy flow chart	It displays the energy flow state of the cabinet. Click the corresponding work interface to view the status information.
3	Status bar	It displays cabinet working status, system time, buzzer status, alarm status, HMI and monitoring communication status, USB status.

Table 3-3 Icons of status bar





Icon	Function description
	Buzzer status. If lit, it indicates the buzzer enabled. If Off, it indicates the buzzer disabled.
	Alarm status. If lit, it indicates there is alarm currently, and if Off, it indicates there is no alarm currently
	HMI communication status. If lit, it indicates the normal communication of HMI monitoring module, and if Off, it indicates the abnormal communication of HMI monitoring module.
	USB connection status. If lit, it indicates that normal connection of USB device, and if Off, it indicates that abnormal or no connection of USB device
	Password login/logout key, click the keyboard to enter the user password or maintenance password. The keyboard will be automatically locked upon locking the screen.

Table 3-4 Description of password right

Password right	Default	Function description
User password	123456	The right of On/ Off control, common setting, and communication setting is unlocked. It may be modified in "Settings - Common Settings - User Password".
Maintenance password	Not open	The right of all controls and settings is unlocked. It is only used by the qualified and authorized professional engineer.

### 3.2.3 System

In the "System" information interface, the "input", "bypass", "battery", "module", "output", "statistics" and "about" information of the system can be inquired in Level 2 menu on the left.

#### Input

The menus of the main input interface are shown in Fig. 3-5. The information of three phase ABC is shown from left to right, and the interface description is shown in Table 3-5.



Fig. 3-5 Input interface

Table 3-5 Description of input interface

Display item	Description
Input voltage (V)	Main input phase voltage
Input current (A)	Main input phase current
Input frequency (Hz)	Main input frequency

### Bypass

The menus of bypass input interface are shown in Fig. 3-6, and the interface description is shown in Table 3-6.



Fig. 3-6 Bypass interface

Table 3-6 Description of bypass interface

Display item	Description
Bypass voltage (V)	Bypass input phase voltage
Bypass current (A)	Bypass input phase current
Bypass frequency (Hz)	Bypass input frequency

### Battery

The menus of battery input interface are shown in Fig. 3-7, and the interface description is shown in Table 3-7.



Fig. 3-7 Battery interface

Table 3-7 Description of battery interface

Display item	Description
Battery voltage (V)	Battery pack voltage
Battery current (A)	Battery pack current
Battery status	Current battery status, including: standing, charging, discharging, charging, floating charging, sleeping, and not connected
SOC (%)	Current remaining battery capacity
Standby time (min)	Estimate discharge time of the battery under the current load
Battery temperature (°C)	Current operating temperature of the battery (battery temperature sensor is required, and it will display "NA" if it is not connected)
Battery quality (%)	SOH

The figure provides is the special information display of the lithium battery (including total battery information, information of battery pack N, battery module information and cell information):

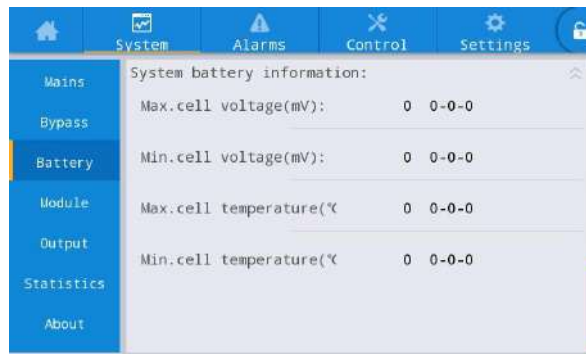

Fig. 3-8 Special information interface of the lithium battery

Table 3-8 Description of special information interface of lithium battery

Display item	Description
Maximum voltage of cell (mV)	Real-time transmit and display the maximum voltage of cell, the battery pack number, the battery pack module number and the module cell number. For example, display: 3147 1-4-4
Minimum voltage of cell (mV)	Real-time transmit and display the minimum voltage of cell, the battery pack number, the battery pack module number and the module cell number. For example, display: 3027 1-5-8
Maximum temperature of cell (°C)	Real-time transmit and display the maximum temperature of cell, the battery pack number, the battery pack module number and the module cell number. For example, display: 30 1-2-4
Minimum temperature of cell (°C)	Real-time transmit and display the minimum temperature of cell, the battery pack number, the battery pack module number and the module cell number. For example, display: 28 1-1-1

At present, the UPS supports the information display of 14 battery packs. The UPS monitors real-time communicates with the lithium battery system to obtain the information on the online battery cabinet. For the online battery cabinet, click the sub-menu lithium BMS battery pack to view, while for battery cabinet is off-line, its off-line is not supported.





Fig. 3-9 Interface of lithium battery pack n

Table 3-9 Description of information of lithium battery pack n

Display item	Description
Battery status	The lithium-ion battery system real-time transmits and displays, including: standing, charging, discharge, failure status.
Battery voltage (V)	The battery voltage is transmitted and displayed real-time by the lithium battery system. For example, display 480
Battery current (A)	The battery current is transmitted and displayed real-time by the lithium battery system. For example, display 30
Maximum voltage of cell (mV)	Real-time transmit and display the maximum voltage of cell, the battery pack number, the battery pack module number and the module cell number. For example, display: 3147 1-4-4
Minimum voltage of cell (mV)	Real-time transmit and display the minimum voltage of cell, the battery pack number, the battery pack module number and the module cell number. For example, display: 3027 1-5-8
Maximum temperature of cell (°C)	Real-time transmit and display the maximum temperature of cell, the battery pack number, the battery pack module number and the module cell number. For example, display: 30 1-2-4
Minimum temperature of cell (°C)	Real-time transmit and display the minimum temperature of cell, the battery pack number, the battery pack module number and the module cell number. For example, display: 28 1-1-1

Information of battery module n (internal core information of battery module)



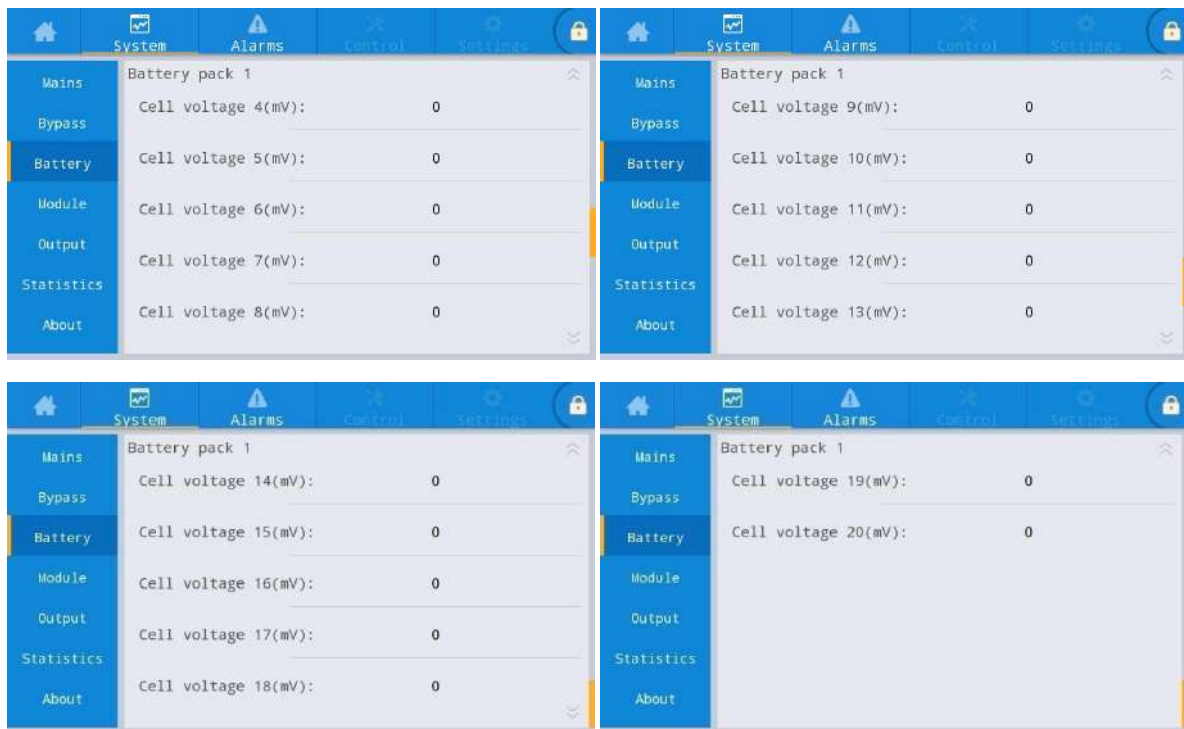

Fig. 3-10 Interface of battery module n

Table 3-10 Description of information of battery module n

Display item	Description
Maximum temperature of battery module n (°C)	Real-time transmit and display the data of lithium battery, for example: Ct MAX(°C): 25
Minimum temperature of battery module n (°C)	Real-time transmit and display the data of lithium battery, for example: Ct Min(°C): 24
Voltage of cell 1 (mV)	Real-time transmit and display the data of lithium battery, for example: CV 1 (mV): 3338
Voltage of cell 2 (mV)	Real-time transmit and display the data of lithium battery, for example: CV 2 (mV): 3338
Voltage of cell 3 (mV)	Real-time transmit and display the data of lithium battery, for example: CV 3 (mV): 3338
Voltage of cell 4 (mV)	Real-time transmit and display the data of lithium battery, for example: CV 4 (mV): 3338
Voltage of cell 5 (mV)	Real-time transmit and display the data of lithium battery, for example: CV 5 (mV): 3338
Voltage of cell 6 (mV)	Real-time transmit and display the data of lithium battery, for example: CV 6 (mV): 3338
Voltage of cell 7 (mV)	Real-time transmit and display the data of lithium battery, for example: CV 7 (mV): 3338
Voltage of cell 8 (mV)	Real-time transmit and display the data of lithium battery, for example: CV 8 (mV): 3338
Voltage of cell 9 (mV)	Real-time transmit and display the data of lithium battery, for example: CV 9 (mV): 3338
Voltage of cell 10 (mV)	Real-time transmit and display the data of lithium battery, for example: CV 10 (mV): 3338



Voltage of cell 11 (mV)	Real-time transmit and display the data of lithium battery, for example: CV 11 (mV): 3338
Voltage of cell 12 (mV)	Real-time transmit and display the data of lithium battery, for example: CV 12 (mV): 3338
Voltage of cell 13 (mV)	Real-time transmit and display the data of lithium battery, for example: CV 13 (mV): 3338
Voltage of cell 14 (mV)	Real-time transmit and display the data of lithium battery, for example: CV 14 (mV): 3338
Voltage of cell 15 (mV)	Real-time transmit and display the data of lithium battery, for example: CV 15 (mV): 3338
Voltage of cell 16 (mV)	Real-time transmit and display the data of lithium battery, for example: CV 16 (mV): 3338
Voltage of cell 17 (mV)	Real-time transmit and display the data of lithium battery, for example: CV 17 (mV): 3338
Voltage of cell 18 (mV)	Real-time transmit and display the data of lithium battery, for example: CV 18 (mV): 3338
Voltage of cell 19 (mV)	Real-time transmit and display the data of lithium battery, for example: CV 19 (mV): 3338
Voltage of cell 20 (mV)	Real-time transmit and display the data of lithium battery, for example: CV 20 (mV): 3338

### Module

The information of each built-in power module is displayed. The menu interface of the module is shown in Fig. 3-11, and the interface description is shown in Table 3-11.



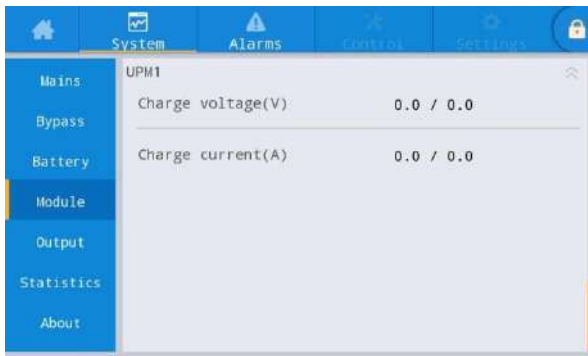

Fig. 3-11 Module interface

Table 3-11 Description of module interface

Display item	Description
Input voltage (V)	Input phase voltage of selected module
Input current (A)	Input phase current of selected module
Input frequency (Hz)	Input frequency of selected module
Input active power (kW)	Input active power of selected module
Input apparent power (kVA)	Input apparent power of selected module
Input power factor	Ratio of input active power to input apparent power of selected module
Output voltage (V)	Output phase voltage of selected module
Output current (A)	Output phase current of selected module
Output frequency (Hz)	Output frequency of selected module
Output active power (kW)	Output active power of selected module
Output apparent power (kVA)	Output apparent power of selected module
Output reactive power (kVa)	Output reactive power of selected module
Output power factor	Ratio of output active power to output apparent power of selected module
Rectifier power supply	Rectifier mode: No power supply, mains supply, battery supply
Output power supply	Output power supply mode: no output, inverter output, bypass output, self - aging
Charge voltage (V)	Charge voltage of selected module
Charge current (A)	Charge current of selected module

### Output

The menus of the output interface are shown in Fig. 3-12, and the interface description is shown in Table 3-12.



Fig. 3-12 Output interface

Table 3-12 Description of output interface

Display item	Description
Output voltage (V)	AC output phase voltage
Output current (A)	AC output phase current
Output frequency (Hz)	AC output frequency
Load percentage (%)	Load ratio of each phase of this UPS, namely ratio of actual power to rated power
Output active power (kW)	Output active power of each phase of this UPS
Output apparent power (kVA)	Output apparent power of each phase of this UPS

### Statistics

The menus of statistics interface are shown in Fig. 3-13, and the interface description is shown in Table 3-13.

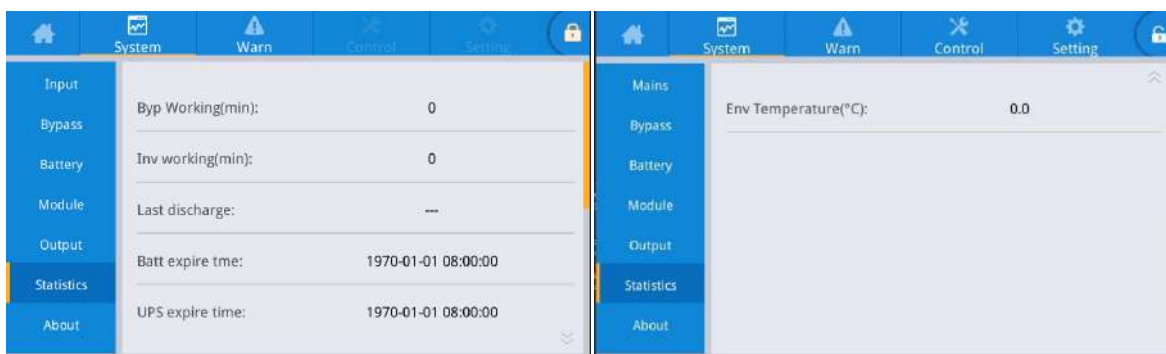

Fig. 3-13 Statistics interface

Table 3-13 Description of statistics interface

Display item	Description
Total bypass operating (min)	Total operating time of the UPS in the bypass output state
Total inverter operating time (min)	Total operating time of UPS in the bypass output state
Latest discharge time	Date and time of latest discharging status of UPS
Battery warranty expiration time	When the system time exceeds the warranty expiration time, the status bar displays the battery warranty expiration information
Warranty expiration time of main machine	When the system time exceeds the warranty expiration time, the status bar displays the warranty expiration information of the main machine
Ambient temperature (°C)	Current operating temperature of UPS (Ambient temperature sensor is required, and "NA" is displayed in case of no connection)

### About

The menu of About interface is shown in Fig. 3-14, and the interface description is shown in Table 3-14.

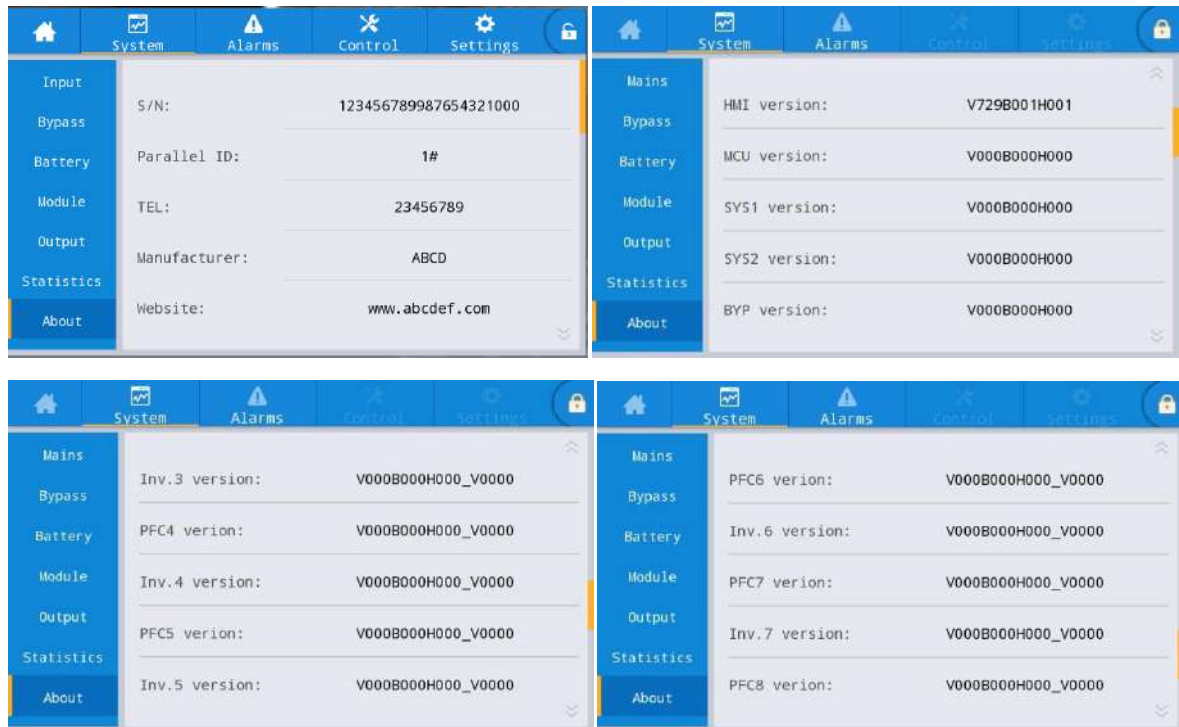

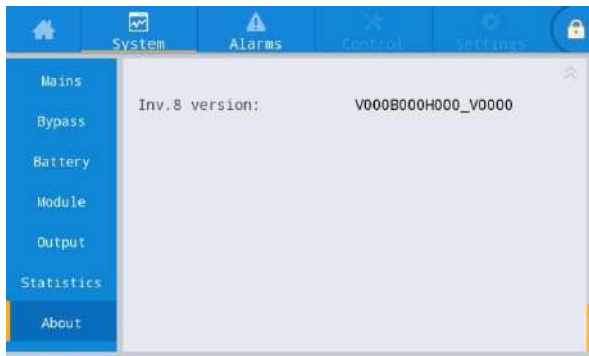

Fig. 3-14 About interface

Table 3-14 Description of About interface

Display item	Description
Serial number	Serial number of UPS
Cabinet number	Used to distinguish the cabinet address in parallel system
Tel.	Contact information of after-sale service provider
Manufacturer	Manufacturer of UPS
Website	Website of manufacturer
Display version	Version of HMI display system program
Monitor version	Version of monitoring system program
Version of system board 1	Program version of system board 1DSP
Version of system board 2	Program version of system board 2DSP
Bypass version	Program version of bypass control board DSP
Version of rectifier 1	Program version of rectifier control board DSP of power module 1
Version of inverter 1	Program version of inverter control board DSP of power module 1
Version of rectifier 2	Program version of rectifier control board DSP of power module 2
Version of inverter 2	Program version of inverter control board DSP of power module 2
Version of rectifier 3	Program version of rectifier control board DSP of power module 3
Version of inverter 3	Program version of inverter control board DSP of power module 3
Version of rectifier 4	Program version of rectifier control board DSP of power module 4
Version of inverter 4	Program version of inverter control board DSP of power module 4
Version of rectifier 5	Program version of rectifier control board DSP of power module 5
Version of inverter 5	Program version of inverter control board DSP of power module 5
Version of rectifier 6	Program version of rectifier control board DSP of power module 6
Version of inverter 6	Program version of inverter control board DSP of power module 6
Version of rectifier 7	Program version of rectifier control board DSP of power module 7
Version of inverter 7	Program version of inverter control board DSP of power module 7
Version of rectifier 8	Program version of rectifier control board DSP of power module 8
Version of inverter 8	Program version of inverter control board DSP of power module 8

### 3.2.4 Alarm

In the "Alarm" information interface, "Current Alarm", "Fault Record", "Status Record" and "Operation Record" can be viewed in Level 2 menu in the lower left corner. The menu of the alarm interface is shown in Fig. 3-15

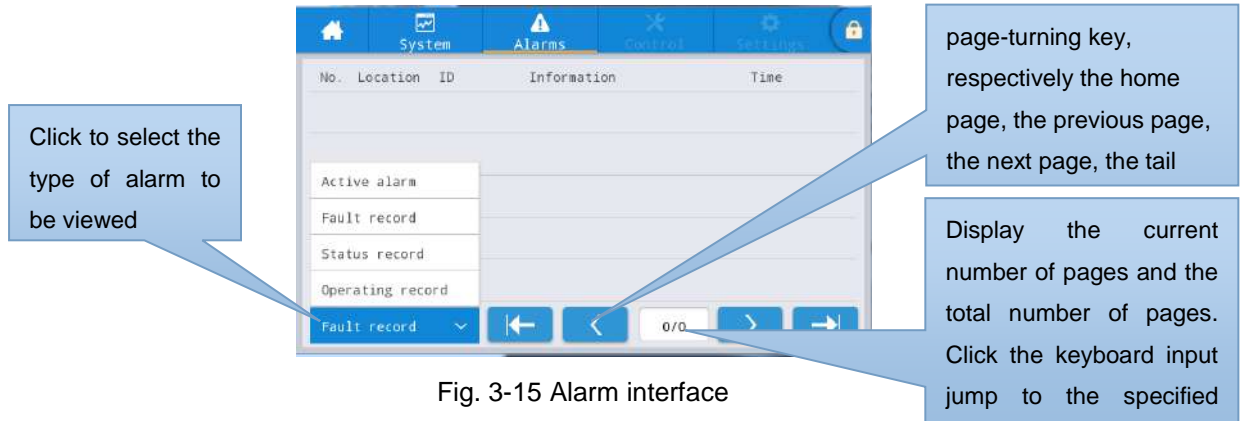

Fig. 3-15 Alarm interface

#### Current alarm

The current alarm interface displays the relevant information of the current alarm of the UPS system, as shown in Fig. 3-16, and the interface description is shown in Table 3-15.



Fig. 3-16 Current alarm interface

Table 3-15 Description of current alarm interface

Display item	Description
Number	Alarm number
Location	Display the cabinet number and module number of the current alarm source
ID	Alarm list code
Information	Name of current alarm
Time	The current alarm is the information that the machine is warning. The time is not displayed.

#### History record

"History Record" is divided into "Fault Record", "Status Record" and "Operation Record". The fault record interface is shown in Fig. 3-17, and the interface description is shown in Table 3-16.

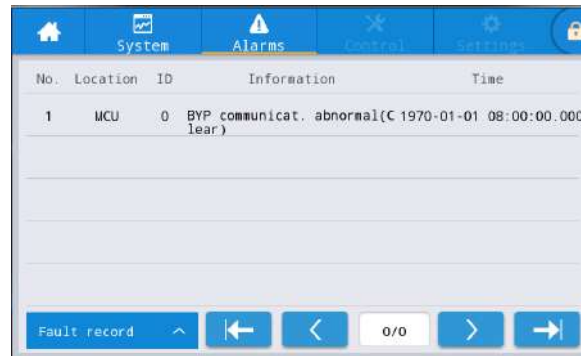

Fig. 3-17 Fault record interface

Table 3-16 Description of history record interface

Display item	Description
Number	Record item number. The records are listed in reverse order, that is, the most recent record in the first.
Location	Displays the module number of the current recording source.
ID	Fault list code
Information	Current record name and record status (occurrence, disappearance).
Time	Occurrence or disappearance time of record

### 3.2.5 Control

In the "Control" information interface, relevant operations can be performed in Level 2 menu on the left, which includes "ON/ OFF", "Maintenance" and "Firmware Upgrade".

#### ON/ OFF

The menu of the ON/ OFF interface is shown in Fig. 3-18, and the interface description is shown in Table 3-17.

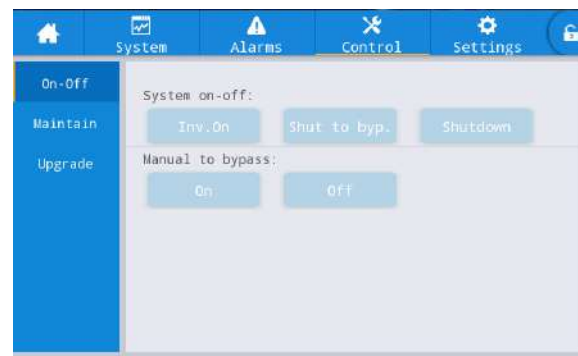

Fig. 3-18 ON/ OFF interface

Table 3-17 Description of ON/ OFF interface

Control item	Description
System ON/ OFF interface	Including ON, switching to bypass after shutdown, disconnect output after shutdown. The key is gray if invalid.
Manually switching to bypass	Including ON, Off. The key is gray if invalid. If the bypass is abnormal, the ON button is gray.

### Maintenance

The menu of the maintenance interface is shown in Fig. 3-19, and the interface description is shown in Table 3-18.

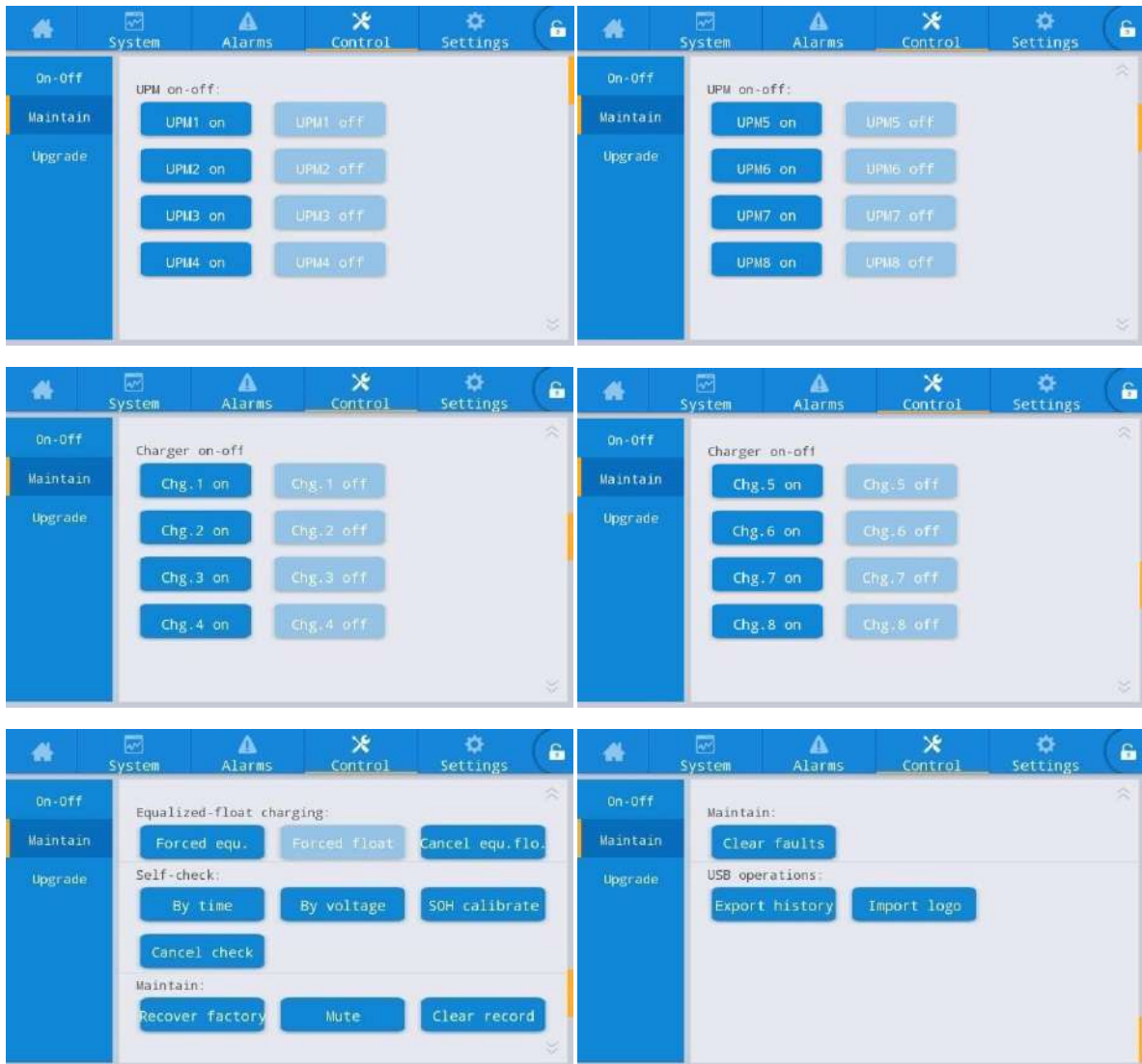

Fig. 3-19 Maintenance interface

Table 3-18 Description of maintenance interface

Control item	Description
Module On/ OFF	On/ OFF of each online module can be controlled.
Charger On/ OFF	On/ OFF of each online module charger can be controlled.
Forced uniform and floating charge control	Including forced uniform charging, forced floating charging, cancellation of forced floating charging, time-based forced uniform charging.
Self-check control	Including self - check by time, self - check by voltage, SOH calibration, cancel self - test.
Maintenance management	Including restoring factory set, buzzer disabling, resetting history, resetting fault.
USB guide	Including exporting history (export Excel document), and importing LOGO(importing starting animation).



### Export history record

A USB device connection is required, and the exported history file is stored appear in the root directory. The information format of the exported history record is shown in Fig. 3-20, and the description of the format is shown in Table 3-19.

Time	Ms	Type	Source	ID	Event	Status	Value
2020/12/30 15:37	895	FAULT	ECU1	640	Bypass flowing backwards	Disappear	0
2020/12/30 15:37	895	FAULT	ECU2	640	Bypass flowing backwards	Disappear	0
2020/12/30 15:37	895	FAULT	ECU1	640	Bypass flowing backwards	Occur	0
2020/12/30 15:37	895	FAULT	ECU2	640	Bypass flowing backwards	Occur	0
2020/11/2 14:43	600	FAULT	PFC4	339	Battery disconnected	Disappear	0
2020/11/2 14:43	900	FAULT	PFC1	339	Battery disconnected	Disappear	0
2020/11/2 14:43	900	FAULT	PFC2	339	Battery disconnected	Disappear	0
2020/11/2 14:43	900	FAULT	PFC3	339	Battery disconnected	Disappear	0
2020/11/2 11:37	520	FAULT	INV7	603	Bypass phase A	Occur	0
2020/11/2 11:37	520	FAULT	INV7	604	Bypass phase B	Occur	62
2020/11/2 11:37	520	FAULT	INV7	605	Bypass phase C	Occur	83
2020/11/2 8:35	487	EVENT	PFC12	1414	Mains power supply	/	0
2020/11/2 8:35	487	EVENT	PFC1	1414	Mains power supply	/	0

Fig. 3-20 Information of exported history record

Table 3-19 Table Description of table format

Display item	Description
Monitor	Mentoring board
ECU1	System board 1
ECU2	System board 2
PFC1	Rectifier board 1
PFC2	Rectifier board 2
INV1	Inverter board 1
INV2	Inverter board 2
Time	Occurrence/disappearance time
Ms	Occurrence time of record in milliseconds
Source	Record source
ID	Fault list code
Event	Record name
Status	Record status (occurrence/disappearance)
Value	Display setting/failure values

### Firmware upgrade

The menus of the firmware upgrade interface are shown in Fig. 3-21, and the interface description is shown in Table 3-20.

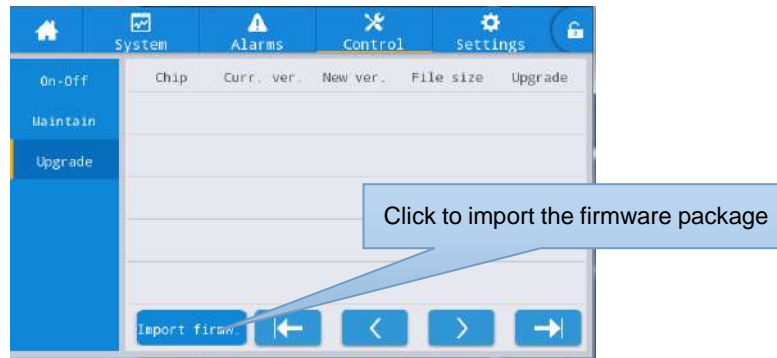

Fig. 3-21 Firmware upgrade interface

Table 3-20 Description of firmware upgrade interface

Display item	Description
Chip	Display the name of online chip
Current version	Display the current program version of the chip
Version of new firmware	Program version of the chip in firmware package
File length	File length of the chip in firmware package
Upgrade	When the chip file in the firmware package is verified successfully, the "Upgrade" button will be displayed. Click the button to complete the upgrade. When file validation fails, the upgrade button is hidden and the upgrade is not allowed

## 3.2.6 Setting

### Common setting

The menu of the common setting interface is shown in Fig. 3-22, and the interface description is shown in Table 3-21.

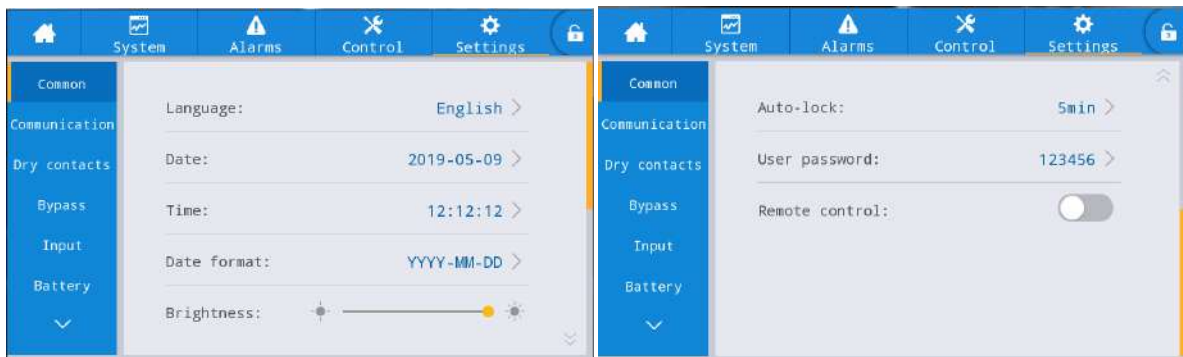

Fig. 3-22 Common setting interface

Table 3-21 Description of common setting interface

Setting item	Default value	Description
Language	Chinese	Currently support 2 languages: Chinese and English;
Y-M-D	2016-01-01	Set the date
Time	00: 00: 00	Set the time
Date format	Y-M-D	Support three formats: Y-M-D, M-D-Y and D-M-Y
Luminance	Maximum	Adjust backlight luminance
Automatic screen protection	5min	Screen protection time. The screen protection is disabled if set to 0.
User password	123456	The users can change the password with 1~8 digits.
Remote control	Disabled	Setting table for Modbus protocol 03 function code of user version; When enabled, the control items in the table, such as "buzzer disabled", "ON/ OFF" and "system clock", support remote setting; When disabled, remote control will not be supported.

### Communication setting

The menus of the communication setting interface are shown in Fig. 3-23, and the interface description is shown in Table 3-22.

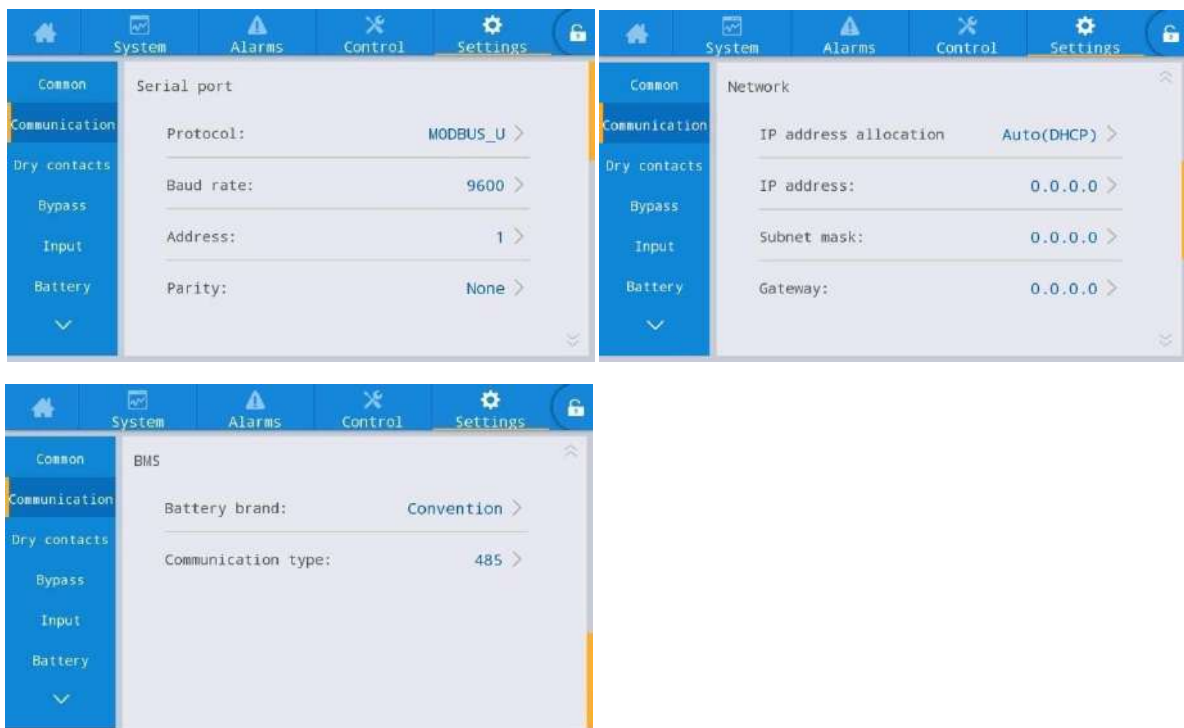

Fig. 3-23 Communication setting interface

Table 3-22 Description of communication setting interface

Setting item	Default value	Description
Protocol	User MODBUS	Set to one of 3 optional communication ports, including user MODBUS, R&D MODBUS and MEGATEC.
Baud rate	9600	Settable to 2400, 4800, 9600, 14400, 19200 and 38400.
Address	1	Settable to 1~247
Check	No	Settable to no check, odd check and even check
IP assignment mode	Dynamic (DHCP)	Settable to dynamic assignment and static assignment; When the UPS is connected to the router, it can be set to dynamic assignment, and the router will automatically assign addresses. When the UPS is connected directly to a computer, it is set to manual assignment, and the IP address of the UPS is set to the same subnet as the IP address of the computer.
IP address	0.0.0.0	Set the IP address of UPS
subnet mask	0.0.0.0	Set the subnet mask of UPS
Gateway	0.0.0.0	Set the gateway of UPS
Battery BMS(only for lithium battery)	Battery brand: conventional	Select the brand of the used lithium battery so that UPS can normally communicate with the lithium battery.
	Communication type: 485	Mode of communication between the UPS and the lithium battery, settable to RS485 or CAN, defaulting to RS485

### Dry contact setting

The menus of the dry contact setting interface are shown in Fig. 3-24, and the interface description is shown in Table 3-23.

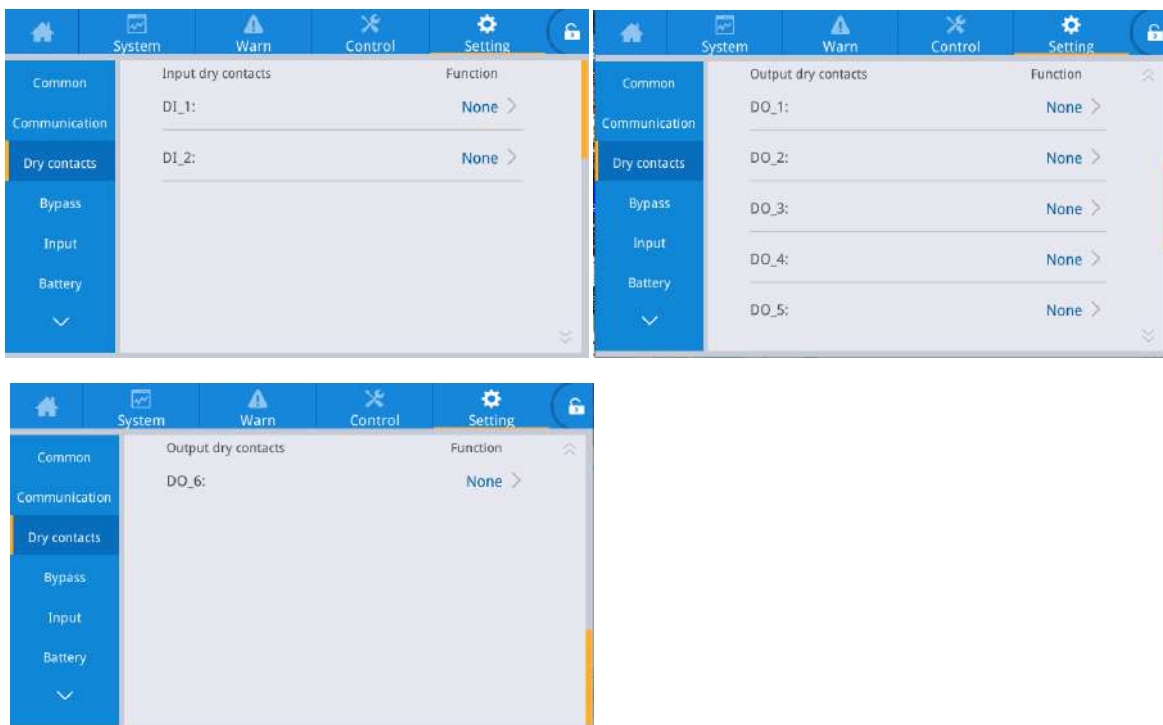

Fig. 3-24 Dry contact setting interface

Table 3-23 Description of dry contact setting interface

Setting item	Default value	Description
DI_1~DI_2	None	2 external input dry contact interfaces, which is settable to no/door magnetic alarm/water logging alarm
DO_1~DO_6	None	6 external output dry contact interfaces, which is settable to no/emergency alarm/ secondary alarm/ bypass power supply/battery power supply/ low battery voltage DOD/ low battery voltage EOD/ diesel generator control/battery switch trip/bypass fault/fan fault/time-share power down

### Bypass parameters

The menus of the bypass parameter interface are shown in Fig. 3-25, and the interface description is shown in Table 3-24.

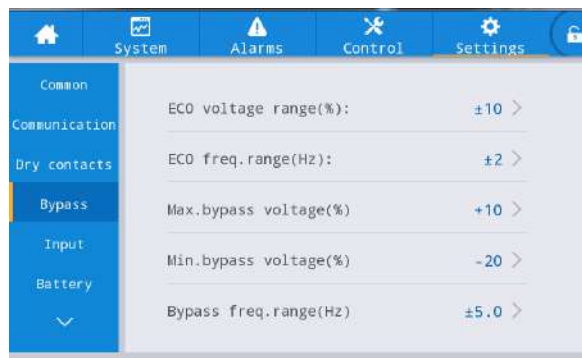

Fig. 3-25 Bypass parameter interface

Table 3-24 Description of bypass parameter interface

Setting item	Default value	Settable value	Description
ECO voltage range (%)	±10	±5/±6/±7/±8/±9/±10	When the deviation of the bypass voltage relative to the rated voltage exceeds the set value, the system determines that the ECO voltage is abnormal, and the system is switched to supply the power by the inverter. Note that the ECO voltage and frequency range are smaller than the bypass voltage and frequency range. For example, if the bypass frequency range is set to ±2Hz, then the ECO frequency range can only be set to ±1Hz
ECO(Hz)	±2	±1/±2/±3	
Upper bypass voltage limit (%)	+15	+10/+15/+20/+25	Maximum settable range from 88Vto 276V. Generally it is set to the voltage range acceptable to the user's electrical equipment.
Lower bypass voltage limit (%)	-20	-10/-20/-30/-40/-50/-60	
Bypass frequency range (Hz)	±5.0	±2.0/±3.0/±4.0/±5.0/±6.0	Note that the bypass frequency range is greater than the ECO frequency range.

## Input parameters

The menus of the input parameter interface are shown in Fig. 3-26, and the interface description is shown in Table 3-25.

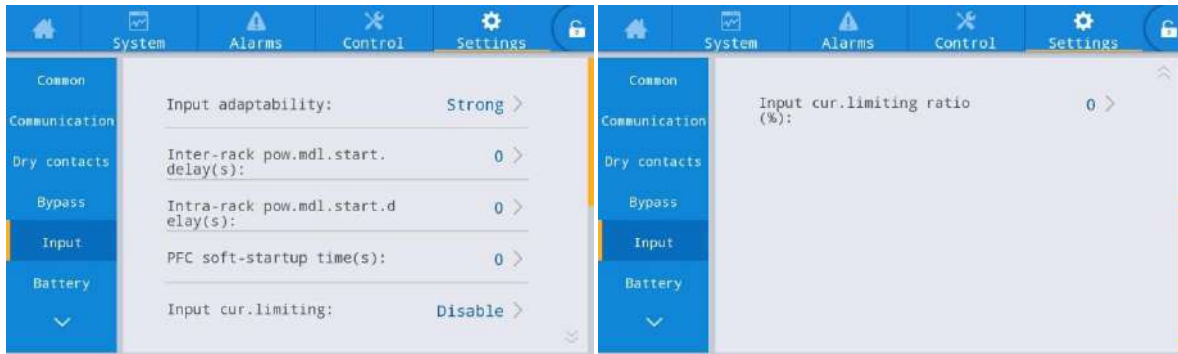

Fig. 3-26 Input parameter interface

Table 3-25 Description of input parameters interface

Setting item	Default value	Settable value	Description
Input adaptation	Strong	Strong /weak	The strong input adaptation mode is suitable for the diesel generator or the input source with high frequency oscillation of the input current. The THDi is slightly worse in this mode, but the system is more stable. The weak input adaptive mode is suitable for the input source with better performance such as mains power and AC voltage source, and the input THDi is better in this mode.
Power unit starting delay between racks (s)	2	0~120	By setting the starting delay for the intelligent generator between the racks, the interval time for each rack to change to main power supply is controlled in the process of supplying the power by changing from the battery inverter to the main inverter to reduce the impact of the UPS on the generator or the power grid.
Power unit starting delay between racks (s)	2	0~300	By setting the starting delay for the intelligent generator between the racks, the interval time for each rack to change to main power supply is controlled in the process of supplying the power by changing from the battery inverter to the main inverter to reduce the impact of the UPS on the generator or the power grid.
Soft starting of rectifier (s)	10	0~60	The starting time of the module is controlled by setting the soft starting time of the module rectifier.

Setting item	Default value	Settable value	Description
Input adaptation	Strong	Strong /weak	The strong input adaptation mode is suitable for the diesel generator or the input source with high frequency oscillation of the input current. The THDi is slightly worse in this mode, but the system is more stable. The weak input adaptive mode is suitable for the input source with better performance such as mains power and AC voltage source, and the input THDi is better in this mode.
Input current limit	Allowed	Prohibited /allowed	According to the actual needs of the users, the input current limit is set for the UPS system to protect the generator equipment.
Input current limit percent (%)	200	50~200	When "Input Current Limit" is set to "Allowed", the current limit value of the main circuit input can be changed by setting this option. The unit is the rated input current percentage ranging from 50% to 200%. It is set according to the output capacity of the generator equipment.

### Battery parameters

The menus of the battery parameter interface are shown in Fig. 3-27, and the interface description is shown in Table 3-26.



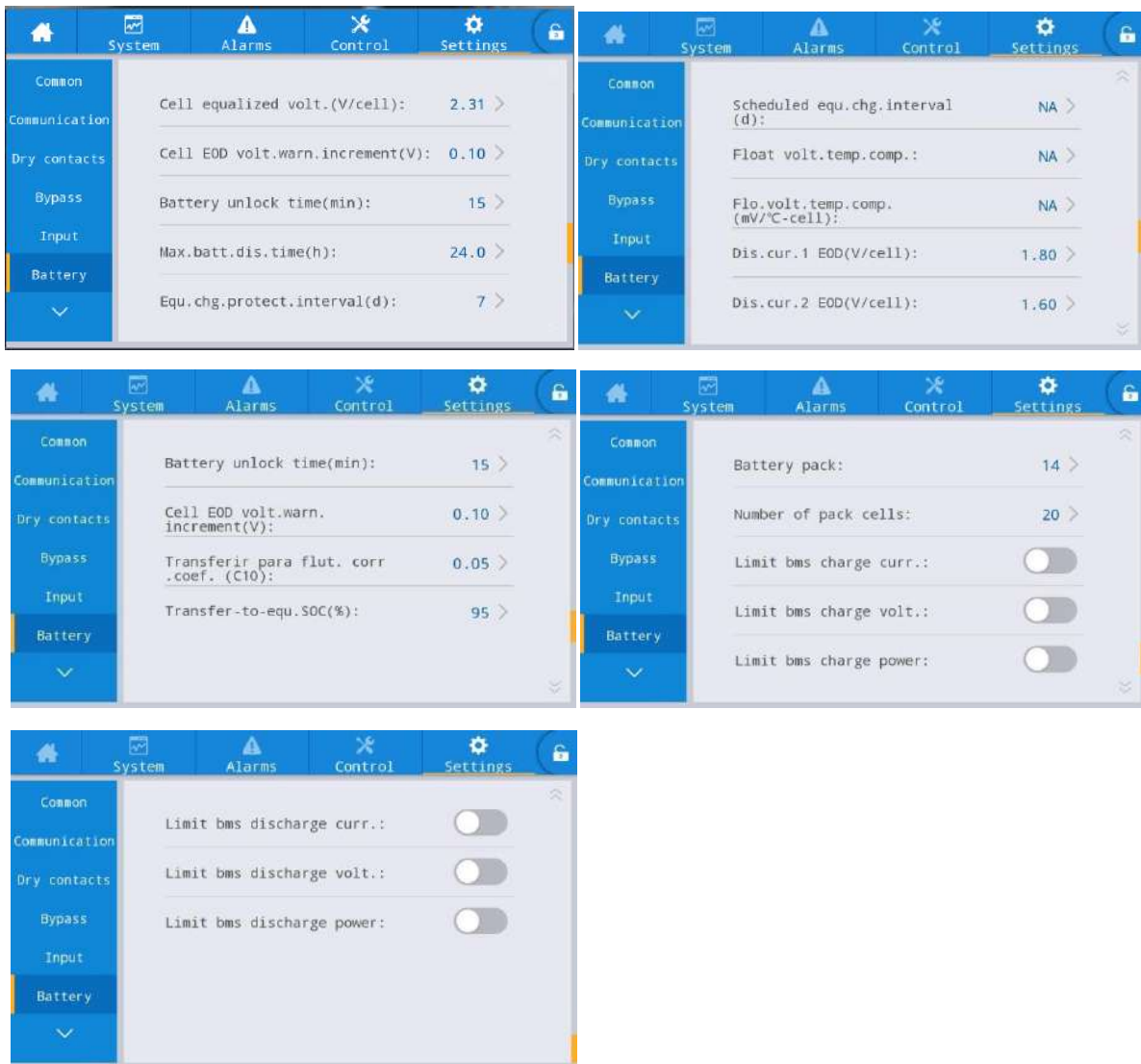

Fig. 3-27 Battery parameter interface

Table 3-26 Description of battery parameter interface

Setting item	Default value	Settable value	Description
Battery type	Lead batteries	Lead batteries / lithium battery	The type of the battery connected with the UPS system. Support the iron phosphate lithium battery 3.2V
Battery capacity (Ah)	100	5~3000	Capacity of the battery connected with the UPS system



Cell number	Lead batteries: 240 Lithium battery: 160	Lead battery: 180~276 (30-46 cells) Lithium battery: 120~160	Total number of cells connected with the UPS system. The conventional lead battery consists of 6 cells and the conventional lithium battery consists of 15 or 16 cells. Lead battery: default to 240, settable to 180-276, the integral multiple of 12 Lithium battery: default to 160, settable to 120-160, the integral multiple of 15/16 Lithium battery: Default value: $3.2V \times 16 \times 10 = 512V$ Settable to 8/10 module ( $\pm 4/\pm 5$ , 15 or 16 cell / module), namely the cell number is 120/128/150/160 (integral multiple of 15/16 )
Battery pack number	1	Lead battery: 1~10 Lithium battery: 1~14	Number of parallel battery pack connected with the UPS system
Battery pack form	Lead battery: shared Lithium battery: independent	Shared/ independent	The battery pack may be shared for multiple UPSs or independently used for the single UPS.
Battery self-check enabling	Disabled	Disabled /by time/ by voltage	If enabled, the UPS system can automatically switch to the discharge in the battery mode according to relevant setting.
Starting time of automatic self-check	00: 00	00: 00~23: 59	If enabled, the UPS system can automatically switch to start the discharge self-check in the battery inverter mode at the set time.
Ending time of automatic self-check	06: 00	00: 00~23: 59	If enabled, the UPS system can automatically switch to change the battery inverter to the main inverter, and stop the self-check at the set time.
Constant current charge time of battery (h)	24.0	0~100.0	The duration of constant current charging of the battery in uniform charging phase
Longest discharge time (h)	24.0	0~48.0	The longest time of continuous discharge of battery in discharge status. When the discharge time reaches this value, if the bypass is normal, the system will switch to the bypass; if the bypass is abnormal, the system will power down and shut down
Automatic self-check period (d)	60	30~90	If the battery self-check is enabled, the UPS system conducts battery discharge self-check within the set time of the set period.

Self-check time of battery (h)	0.0	0.0~23.0	If the battery self-check is enabled and the self-check by time is selected, the UPS system will switch to the battery inverter for discharge self-check at set time till the self-check duration reaches the set time. Note that set the set self-check time should be within the automatic self-check period, otherwise, the self-check fails.
Voltage upon completion of battery self-check (V/cell)	Lead battery: 1.70 Lithium battery: 3.10	Lead battery: 1.60~1.90 Lithium battery: 2.50~3.50	If the battery self-check is enabled and the self-check by voltage is selected, the UPS system will switch to the battery inverter discharge self-check at set time till the cell voltage reaches the voltage for ending the self-check, or the set self-check ending time is reached.
Standby time alarm	Prohibited	Prohibited / allowed	If the alarm function is enabled, the system will give an alarm if the standby time reaches the set value.
Standby time alarm threshold (min)	5	3~30	
SOC pre-alarm	Prohibited	Prohibited / allowed	If the alarm function is enabled, the system will give an alarm if the SOC reaches the set value.
SOC pre-alarm threshold (%)	20	5~50	
Battery quality SOH(%)	100	0~100	Ratio of actual battery capacity to nominal capacity after the battery is used for a period.
Charge current limit coefficient (C10)	Lead battery: 0.10 Lithium battery: 0.20	Lead battery: 0.05~0.15 Lithium battery: 0.05~1.00	The user may set the charge current limit
Floating charge voltage of cell (V/cell)	Lead battery: 2.25 Lithium battery: 3.40	Lead battery: 2.23~2.27 Lithium battery: 3.30~3.65	Charge voltage of cell in floating charge status
Even charge voltage of cell (V/cell)	Lead battery: 2.31 Lithium battery: 3.40	Lead battery: 2.30~2.40 Lithium battery: 3.30~3.65	Charge voltage of cell in even charge status
High battery temperature alarm point (°C)	50 (30)	45 (20)~55	The battery temperature can be monitored in time. When the battery temperature is detected to be higher than the high temperature alarm point or lower than the low temperature alarm point, the system will give an alarm.
Low battery temperature alarm point (°C)	-5	-20~5	

Even charge protection time interval (d)	7	0~15	The interval between the change from even charging to floating charging and next time of even charging if the battery is not discharged.
Timed even charge interval (d)	60	30~180	If the duration reaches the even charging interval after the even charging, the system will automatically and evenly charge the battery.
Temperature compensation at floating charge voltage	Prohibited	Prohibited / allowed	If this function is enabled, the system can automatically perform temperature compensation and correction for the floating charging voltage according to the battery temperature, and the reference value of temperature compensation is 25°C
Temperature compensation coefficient at floating charge voltage (mv/°C·cell)	3.3	0~6.0	
Discharge current 1 EOD(V/cell)	Lead battery: 1.80 Lithium battery: 3.00	Lead battery: 1.75~1.90 Lithium battery: 2.50~3.00	Lead battery: EOD voltage of cell when the discharge current is 0.1C Lithium battery: EOD voltage of cell when the discharge current is 2C or lower.
Discharge current 2 EOD(V/cell)	Lead battery: 1.60 Lithium battery: 2.70	Lead battery: 1.60~1.75 Lithium battery: 2.50~3.00	Lead battery: EOD voltage of cell when the discharge current is 0.1C Lithium battery: EOD voltage of cell when the discharge current is more than 2C.
Battery unlocking time (min)	15	1~60	If the switching times is 5 times between the battery inverter and the battery inverter within an hour, the battery inverter will be locked, and the unlocking time may be set by this option.
EOD voltage alarm increase of cell (V)	0.10	0~0.20	EOD voltage of cell increased by the set value is increased. If the voltage of the cell reaches this value, the battery EOD pre-alarm is given.
Consistent voltage even charge time of battery (h)	48.0	0~100.0	Consistent voltage even charging time in even charging process
Coefficient for change to floating charge current	0.05	0.02~0.08	The user may set the current limit for change to floating charging

SOC for change to even charging (%)	95	0-100	The user may set the SOC for change to even charging
Battery module number	Lead battery: no Lithium battery: 10	Lead battery: no Lithium battery: 1-14	Set the number of lithium battery module. If the number of the online modules is the set value, an alarm is given.
Module cell number	Lead battery: no Lithium battery: 16	Lead battery: no Lithium battery: 1-16	Set the cell number in the lithium battery.If the number of the online cells is the set value, an alarm is given.
BMS charge current limit	Lead battery: no Lithium battery: prohibited	Lead battery: no Lithium battery: prohibited /allowed	Set BMS charge current limit, default: prohibited
BMS charge voltage limit	Lead battery: no Lithium battery: prohibited	Lead battery: no Lithium battery: prohibited /allowed	Set BMS charge voltage limit, default: prohibited
BMS charge power limit	Lead battery: no Lithium battery: prohibited	Lead battery: no Lithium battery: prohibited /allowed	Set BMS charge power limit, default: prohibited
BMS discharge current limit	Lead battery: no Lithium battery: prohibited	Lead battery: no Lithium battery: prohibited /allowed	Set BMS discharge current limit, default: prohibited
BMS discharge voltage limit	Lead battery: no Lithium battery: prohibited	Lead battery: no Lithium battery: prohibited /allowed	Set BMS discharge voltage limit, default: prohibited
BMS discharge power limit	Lead battery: no Lithium battery: prohibited	Lead battery: no Lithium battery: prohibited /allowed	Set BMS discharge power limit, default: prohibited

## Output parameters

The menus of the output parameter interface are shown in Fig. 3-28, and the interface description is shown in Table 3-27.

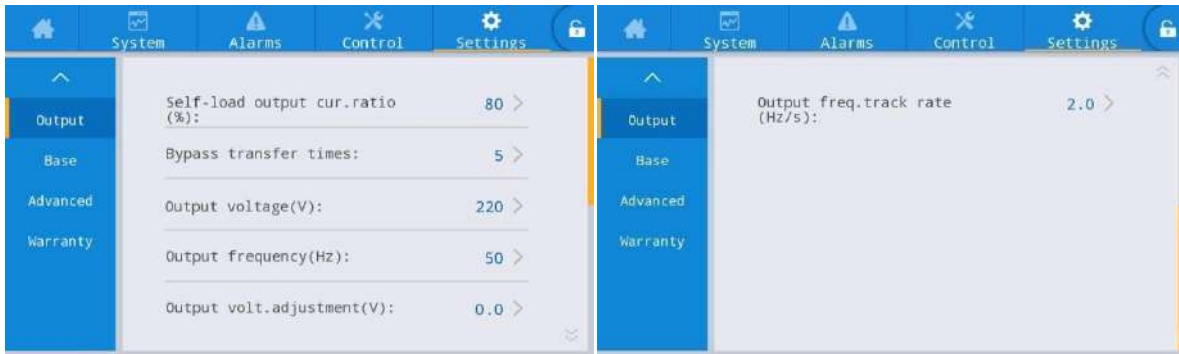

Fig. 3-28 Output parameter interface

Table 3-27 Description of output parameter interface

Setting item	Default value	Settable value	Description
Output frequency tracking rate (Hz/s)	2.0	0.5~2.0	It is set according to the load capacity. If the tracking rate is too slow, when the bypass frequency changes, the working frequency of the inverter will be out of sync with the bypass frequency
Bypass switching time	5	1~10	Settable to 1-10 times, default: 5 times. If the bypass switching times reach the set value within one hour, the system will be locked. In normal mode, the bypass end will be locked for output power supply; in ECO mode, the inverter end will be locked for output power supply
Output voltage (V)	220	220/230/240	The user may set the output voltage amplitude acceptable to the load, which shall be set after the output disconnection.
Output frequency (Hz)	50	50/60	The user may set the output voltage frequency acceptable to the load, which shall be set after the output disconnection.
Output voltage tuning (V)	0.0	-5.0~5.0	Tune the output voltage according to customer's field distribution
Percentage of self-aging output current (%)	80	20~100	In self - aging mode, ratio of output current to rated output current

## Basic parameter

The menus of the basic parameter interface are shown in Fig. 3-29, and the interface description is shown in Table 3-28.

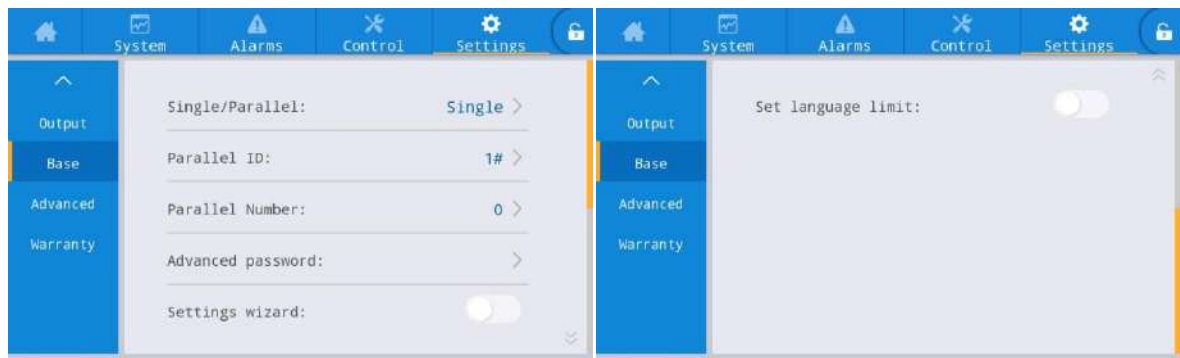

Fig. 3-29 Basic parameter interface

Table 3-28 Description of basic parameter interface

Setting item	Default value	Settable value	Description
Single and parallel	Single	Single, parallel	Set according to the actual number of online racks in the system. If only one rank operates, select "single machine", and select the "parallel" if two racks operates.
Cabinet number	1#	1~4	Each single UPS of the parallel system should be number respectively.
Number of system rack	1	1~4	The system is divided into a single system and a parallel system which supports the parallel operation of up to 4 racks.
Maintenance password	/	0~99999999	The authorized professional engineers can use and change the password, and the password can be set to 1~8 digits and cannot be the same with the user password. If the users need to know the password, they need to consult the supplier.
Quick setting	Enabled	Enabled/disabled	If enabled, the quick setting interface can be displayed after restarting the UPS.
Language setting limit	Disabled	Enabled/disabled	If enabled, the language is limited to special language and can not be set.

### Advanced parameters

The menus of the basic parameter interface are shown in Fig. 3-30, and the interface description is shown in Table 3-29.

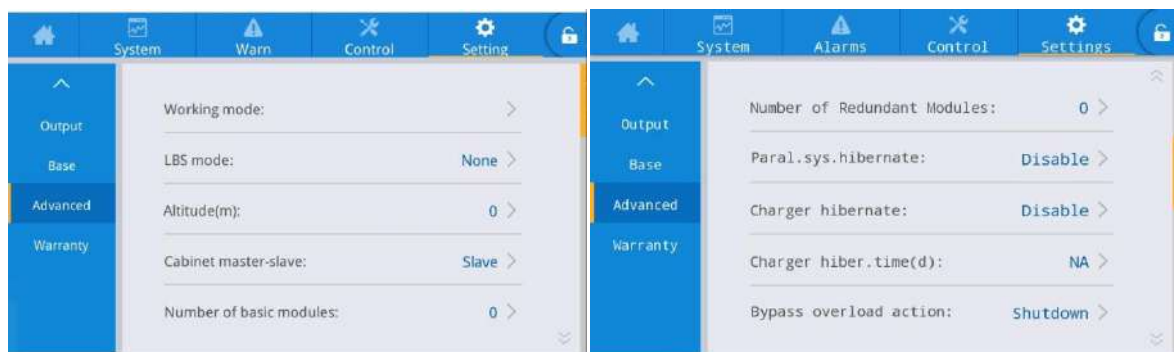

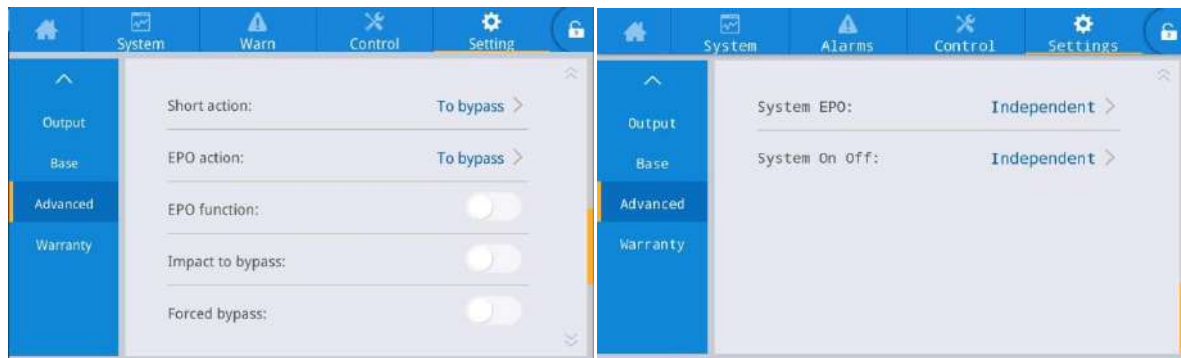

Fig. 3-30 Advanced parameter interface

Table 3-29 Description of advanced parameter interface

Setting item	Default value	Settable value	Description
Operating mode	Normal	Normal /ECO/self-ageing/transducer	The operating mode is set as needed by the users, and generally set to the normal operating mode.
LBS mode	Non-LBS	Non-LBS/ master LBS/ slave LBS	If the user needs to use the double bus system, it can be set according to the actual situation
Altitude(m)	1000	0~3000	It is set according to the actual situation of the user's site. The output capacity will be decreased according to the set value. See the derating description in Chapter 7 "Technical Parameters " for details
Rack master-slave setup	Master	Master / slave	This setting item does not need to be set and is automatically assigned by the system upon parallel operation.
Number of basic modules in rack	12	1~12	Number of basic modules in rack
Number of redundant module in rack	0	0~11	Number of redundant module in rack
Smart parallel sleep mode	Disabled	Enabled / disabled	According to the system configuration and the user's requirements, smart parallel sleep is set, so that the parallel system automatically decides the number of UPS units or modules to be put into operation according to the current total load size. Under the condition of ensuring redundant power supply, redundant UPS can be quit and put into sleep state, so as to achieve the purpose of safe operation and energy saving
Charger sleep	Enabled	Enabled / disabled	If allowed, when the charger meets the sleep, the charger enters the sleep status. If disabled, the charger does not enter the sleep status
Charger sleep time (d)	28	28~60	If the "charger sleep" function is enabled, and the set battery sleep time is over, the charger quits the sleep status.

Setting item	Default value	Settable value	Description
Bypass overload action	Output disconnection	Output disconnection and no action	When the bypass overload time is over, the UPS system will disconnect the output or not operate. Modification of this option requires authorization from the manufacturer, otherwise no warranty is granted. Selecting the "no action" option may cause the system to fail to protect the bypass in time and damage the bypass device.
Short circuit action	Switching to bypass	Switching to bypass and output disconnection	In case of the short circuit in the output of the UPS system, the UPS system will switch the bypass or disconnect the output.
EPO action	Switching to bypass	Switching to bypass and output disconnection	It is set according to the actual requirements of the user. When the EPO alarm is triggered, the UPS system switches to bypass or disconnect the output. The UPS system defaults to switching to bypass.
EPO function	Enabled	Enabled / disabled	The EPO function is enabled or disabled according to the actual requirements of the user.
Switching to bypass for impact	Enabled	Enabled / disabled	If enabled, when a impact load causes a rapid drop in the output voltage of the UPS system, the system switches to bypass mode for a short period of time.
Forced bypass	Disabled	Enabled / disabled	If enabled, the UPS system will switch to bypass mode for power supply even if the bypass voltage is abnormal when it needs to switch to bypass output power supply. The system is unable to switch to bypass mode when the bypass is UHV. This should be set carefully.
Unified action of EPO system	Disabled	Enabled / disabled	It is required to confirm that the UPS system operates in parallel and the unified action of EPO system is set according to the user's requirements. If enabled, when one UPS reports EPO failure, the whole system will report EPO failure.
Unified system ON/ OFF	Disabled	Enabled / disabled	It is required to confirm that the UPS system operates in parallel and the unified system ON/ OFF is set according to the user's requirements.

## Warranty expiration setting

The menus of the warranty expiration setting interface are shown in Fig. 3-31, and the interface description is shown in Table 3-30.



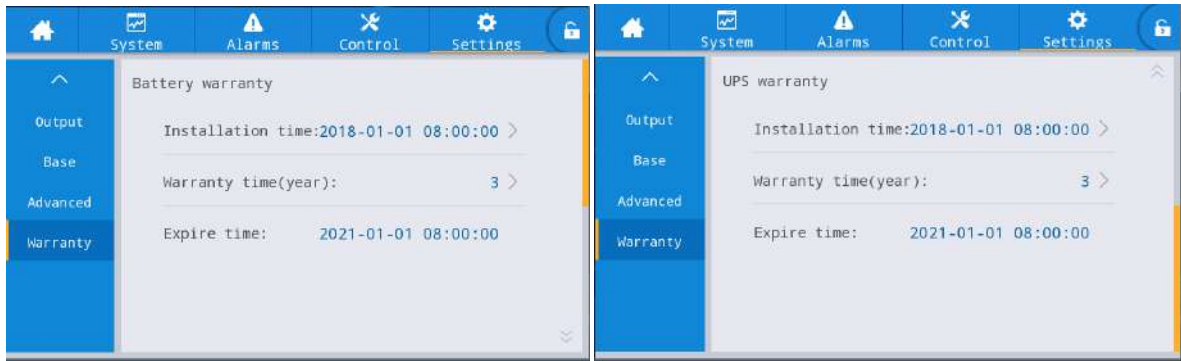

Fig. 3-31 Warranty expiration parameter interface

Table 3-30 Description of warranty expiration parameter interface

Setting item	Default value	Settable value	Description
Battery installation time	2018-01-01 00: 00: 00	Arbitrary value	Click the popping box to confirm the update to the current time
Battery warranty period	3	1~50	Set it according to the warranty time of the battery actually used by the customer
Battery warranty expiration time (non-Setting item)	2021-01-01 00: 00: 00	Not settable	The warranty expiration time is automatically generated according to the installation time and the warranty time. When the system time exceeds the warranty expiration time, the status bar of the home page will display the warranty expiration information.
Installation time of main machine	2018-01-01 00: 00: 00	Arbitrary value	Click the popping box to confirm the update to the current time
Warranty period of main machine	3	1~50	Set it according to the warranty time of the UPS actually used by the customer
Warranty expiration time of main machine (non-setting item)	2021-01-01 00: 00: 00	Not settable	The warranty expiration time is automatically generated according to the installation time and the warranty time. When the system time exceeds the warranty expiration time, the status bar of the home page will display the warranty expiration information.

## Chapter 4 Operation Instructions

### 4.1 Operation of single UPS

#### 4.1.1 Power on UPS

	Attention
	<ul style="list-style-type: none"> <li>• Before on-site wiring and installation, confirm that all switches on the UPS are in the disconnected state.</li> <li>• Check whether all screws are tightened and wiring is correct before starting the UPS.</li> <li>• Main circuit, bypass input, output, battery air switch should be in the disconnected state.</li> <li>• After powering on, please confirm that the [number of basic modules in rack] under Advanced Parameters in the [Settings] interface is consistent with the number of modules actually used.</li> <li>• As required by the load, the [output voltage] and [output frequency] must be set in the [output parameters] in the [Settings] interface before starting.</li> <li>• According to the requirement of the external batteries, before starting, make sure to set [battery type], [battery capacity], [number of cells] and [number of battery packs] in the [settings] interface to ensure that the set parameters match the connected battery packs.</li> </ul>

Operation procedure:

**Step 1:** Connect the external input distribution switch (main input switch and bypass input switch) to power on the system, while the system starts to initialize. At the same time, the company LOGO and initialization progress bar are displayed on the monitor screen. The system is in standby mode.

**Step 2:** After the normal start of monitor, upon powering on for first time, the relevant parameters can be set through the quick setting guide; upon power on again, the system defaults to the last setting. If these parameters have been set, the system defaults to the existing settings. Please refer to Quick Settings in 3.2.1 Settings for the specific operation interface.

**Step 3:** After the quick setting, if there is no abnormal alarm on the display interface, continue the next steps; If there are abnormal alarms on the display interface (since the battery has not been connected at this time, reporting "battery not connected" is a normal alarm), and reset all abnormal alarms.

**Step 4:** Power on the inverter

If [Control] is gray and not selectable on the main menu of the monitoring display unit, unlocking is required first. Click the password lock at the upper right corner of the display interface while the system will pop up an unlocking window, and enter the password, as shown in Fig. 4-1.



Fig. 4-1 Unlocking window

Select [Control] in the main menu of the monitoring display unit, click [Power on], and then complete the inverter starting operation, as shown in Fig. 4-2.

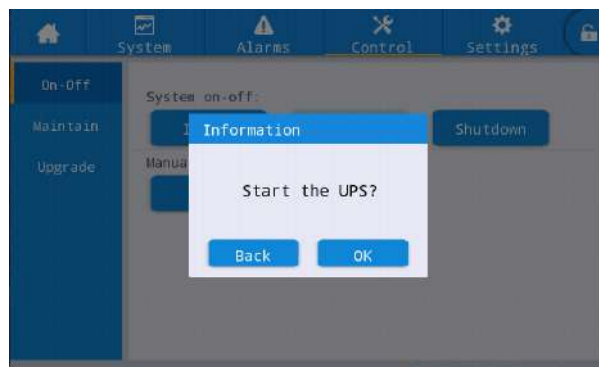

Fig. 4-2 Power on inverter

**Step 5:** After the inverter is powered on, the UPS supplies the power by the inverter, and the system running status can be viewed to verify that the system supplies the power by a main-circuit inverter.

It can be confirmed by the real-time data displayed in [System]→[Output] in the monitoring display interface whether the three-phase output voltage and frequency of the UPS are normal and it can be tested by the multimeter whether the effective value and frequency of the three-phase output voltage are normal, as shown in Fig. 4-3.

Parameter	Phase 1	Phase 2	Phase 3
Voltage(V):	219.9	219.9	220.0
Current(A):	4.4	4.3	8.5
Frequency(Hz):	49.98	49.98	49.98
Load ratio(%):	7.2	7.2	14.1
Active power(kW):	0.9	0.9	1.8

Fig. 4-3 Output information

**Step 6:** Check whether the actual number of the battery packs is consistent with the number of battery packs set on the monitor display interface; Then use the multimeter to measure whether the absolute value of the positive and negative battery voltage is greater than a certain value (for 12V battery, 11.4Vx number of cells) to prove that the battery packs are connected normally

connected. After confirming that the battery packs are connected properly, connect the battery input switch (in case of multiple battery packs, connect the switch of each battery pack first, then the main switch between the battery packs and the UPS). Battery self - check is performed to confirm whether the battery is in normal working condition.

**Step 7:** Connect the external output distribution switch to supply the power to the load.

 Note

- If the UPS has been powered on or is in the bypass power supply mode, and the inverter power supply mode needs to be turned on at this time, perform Step 4 after confirming that there is no abnormal alarm; if the UPS is completely powered off, complete all above step.

### 4.1.2 Power off UPS

<b>Attention</b>	
	<ul style="list-style-type: none"> <li>• When [switching to bypass after shutdown] is selected, if the system bypass is normal after the UPS inverter is shut down, the system enters the bypass power supply mode; if the system bypass is abnormal after shutdown of the inverter, the system enters no-output mode and disconnects the output power.</li> <li>• When [disconnecting output after shutdown] is selected, after shutdown of the inverter, the system directly enters no-output mode and disconnect the output power.</li> <li>• Before shutdown, please make sure that the user's equipment (i.e. load of UPS) has been turned off and can withstand power-off condition at any time.</li> </ul>

Operation procedure:

**Step 1:** Power off the inverter

If [Control] is gray and not selectable on the main menu of the monitoring display unit, unlocking is required first. Click the password lock at the upper right corner of the display interface while the system will pop up an unlocking window, and enter the password, as shown in Fig. 4-1. Select "Control" in the main menu of the monitoring display unit, click [switching to bypass after shutdown], and then complete the operation of "Power off Inverter Shutdown", as shown in Fig.4-4.

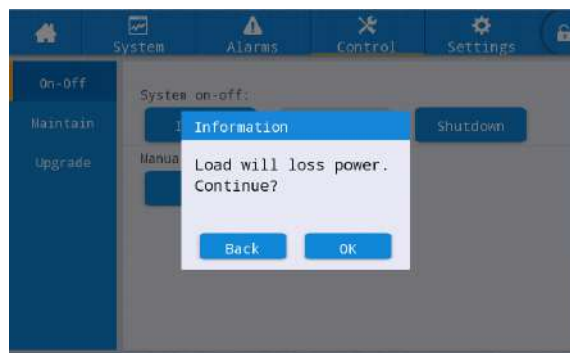

Fig. 4-4 Power off inverter

**Step 2:** The UPS will enter the bypass power supply mode if the system bypass is normal after shutdown of the inverter, and the UPS enters no-output mode and disconnects the output power if the system bypass is abnormal after shutdown of the inverter.

**Step 3:** After shutdown of the inverter, disconnect the external output distribution switch.

**Step 4:** Disconnect the battery switch (if there are multiple batteries, first disconnect the main

switch between the battery pack and the UPS, then disconnect the switch of each battery pack).

**Step 5:** Disconnect the external main input distribution switch and the bypass input distribution switch.

 Note

- If it is only required to power off the UPS inverter to make the system switching to supply power by the bypass, only perform Step after confirming that there is no abnormal alarm in the UPS at present; if it is required to power off the UPS, perform all above steps.

### 4.1.3 Cold starting of battery

Operation procedure:

**Step 1:** Verify that the battery is connected properly, and then use the multimeter to measure whether the absolute value of the positive and negative battery voltage is greater than a certain value ( $11.4V \times$  number of cells for the 12V battery).

**Step 2:** Disconnect the input switch of the external mains and the bypass circuit, and connect the battery switch when there is no input of the main circuit and the bypass circuit (if there are multiple batteries, first connect the switch of each battery pack, and then the main switch between the battery pack and the UPS).

**Step 3:** Use the multimeter to measure the positive and negative battery voltage at the input end of the UPS battery. If the absolute value of both the positive voltage and negative battery voltage is greater than a certain value (for 12V battery,  $11.4V \times$  number of cell), the battery is normally connected.

**Step 4:** Press the red cold starting button of the battery on the bypass module for more than 3 seconds. The cold starting button of the battery is located beside the red button on the handle of the bypass module, and the system will automatically enter the cold starting state of the battery. At the same time, the monitoring display unit to display the company LOGO and the initialization progress bar.

**Step 5:** After the initialization of the monitoring display unit is completed, start the inverter according Step 4, Step 5 and Step 6 in 4.1.1 Power on UPS.

### 4.1.4 Manual switching to bypass power supply

<b>Attention</b>	
	<ul style="list-style-type: none"> <li>• Before manual switching to bypass, verify that the bypass is normal. If the bypass is abnormal, manual switching to bypass will be invalid. The previous state is maintained continuously.</li> <li>• In the bypass power supply mode, when the input voltage or frequency range exceeds the set value of the system, it is possible to result in no output of the system and power failure of the load.</li> </ul>

Operation procedure:

**Step:** Manual switching to bypass

If [Control] is gray and not selectable on the main menu of the monitoring display unit, unlocking is required first. Click the password lock at the upper right corner of the display interface while the system will pop up an unlocking window, and enter the password, as shown in Fig. 4-1.

Select [Control] in the main menu of the monitoring display unit, click [Enable manual switching to bypass ], and then complete the operation of " manual switching to bypass ", as shown in Fig. 4-5.

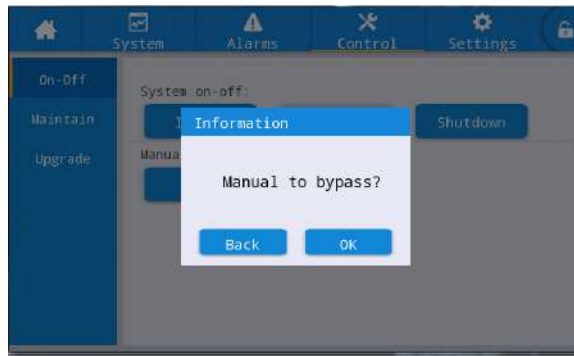



Fig. 4-5 Manual switching to bypass

### 4.1.5 Switching to maintenance bypass

	<b>Attention</b>
	<ul style="list-style-type: none"> <li>• The Switching to maintenance bypass must be completed by the following steps, otherwise, it is possible to cause the power failure of the load.</li> <li>• In the maintenance bypass mode, the mains supplies the power directly to the load through the maintenance bypass. Abnormal mains may result in the power failure of the load.</li> </ul>

**Step 1:** Refer to the steps 4.1.4 "Manual switching to bypass " to make the UPS to supply the power by the bypass.

**Step 2:** First remove the fixing component of the maintenance bypass switch, and then manually disconnect the maintenance bypass switch of the UPS while the UPS system switches to the maintenance bypass mode; The monitoring display interface displays the alarm of "maintenance air switch disconnected".

**Step 3:** Disconnect the input, the bypass, the battery, and the output switches while the UPS system enters the maintenance bypass mode.

### 4.1.6 Change from maintenance bypass power supply to inverter power supply

	<b>Attention</b>
	<ul style="list-style-type: none"> <li>• Before change from maintenance bypass power supply to inverter power supply, verify that system bypass inputs and outputs are normal.</li> </ul>

Operation procedure:

**Step 1:** Disconnect the input switch and bypass switch of the UPS system. After the UPS system power supply is normal, manually start the UPS system while the monitoring display interface displays the alarm of "maintenance air switch disconnected ".At this point, the "Manual Bypass" will automatically open. Check the system operation status diagram in the monitoring display interface to confirm whether the system is switched to the bypass power supply mode. It is forbidden to connect the air switch of the output in advance, otherwise, the short circuit fault of the bypass SCR will be reported.

**Step 2:** Connect the battery switch and the output switch and manually switch the maintenance

bypass switch from "ON" to "OFF". At this time, the maintenance bypass switch will be disconnected. At the same time, the "maintenance air switch connected " alarm disappears from the monitoring interface.

**Step 3:** Click "Manual bypass" to close the manual bypass while the system will return to normal operation. The system operating state diagram can be viewed in the monitoring display interface to verify that the system is in inverter mode.

### 4.1.7 Emergency shutdown (EPO)

	<b>Attention</b>
	<ul style="list-style-type: none"> <li>• In the default setting, EPO operation will not cause the power failure of the UPS, but the system switching to bypass output to prevent accidental power failure. If the UPS is not required to output, set [EPO Action Mode] to [Disconnect Output].</li> <li>• After pressing the "Emergency Shutdown (EPO)" button, it is possible result in no UPS output and the power failure of the load.</li> </ul>

Operation procedure:

**Step:** Unplug the dry contact connector at the normally closed end of the EPO or connect the normally open dry contact and the external EPO switch while the UPS will enter the emergency shutdown state and the monitoring display interface will give an alarm.

### 4.1.8 Recovery after emergency shutdown

Operation procedure:

**Step 1:** Plug the dry contact connector at the normally closed end of the EPO or disconnect the normally open dry contact and connect the external EPO switch and verify that the dry contact connected to the external EPO switch is in a non-emergency shutdown state.

**Step 2:** Clear the emergency shutdown alarm in the system.

Clearance of failure on the monitoring display interface: select [Control]→[Maintenance]→[Fault clearance] in the main menu of the monitoring display unit, and after the prompt dialog box pops up, select OK to clear the emergency shutdown alarm, as shown in Fig. 4-6.

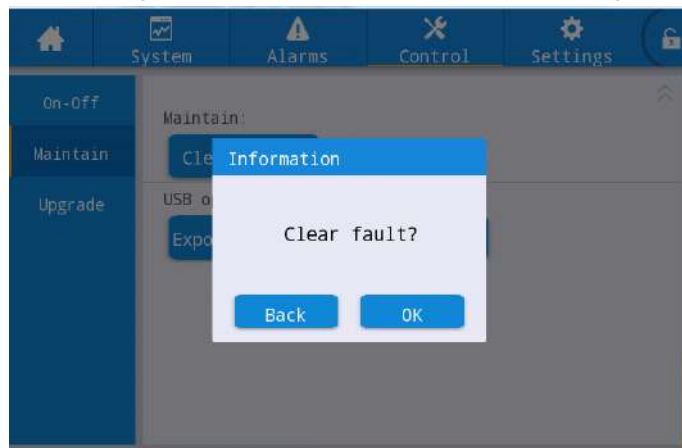



Fig. 4-6 Fault clearance

**Step 3:** View the current alarm and confirm that the "emergency shutdown" alarm disappears. If the bypass input of the system is normal, UPS will switch to the bypass mode for power supply.

**Step 4:** Power on the inverter. Please refer to Step 2 ~Step 6 in Section 4.1.1 " Power on UPS " for specific operation.

### 4.1.9 Firmware upgrade

Attention	
	<ul style="list-style-type: none"> <li>• Before the firmware upgrade, switch the UPS system to the maintenance bypass mode;</li> <li>• During firmware upgrade, power off the inverter and bypass of the UPS and disconnect the output switch of the UPS;</li> <li>• During the firmware upgrade, the USB flash disk and firmware upgrade program are required and should be prepared in advance.</li> </ul>

#### Master control and monitor firmware upgrade

Operation procedure:

**Step 1:** Put the firmware package into the root directory of the USB flash disk, such as the USB drive : \ dspupdate1.img file.

 Note

dspUpdate1.img is BYP program firmware package, dspUpdate2.img is PFC program firmware package, dspUpdate3.img is INV program firmware package, dspUpdate4.img is ECU (SYS) program firmware package, and update file is MCU program firmware package.

**Step 2:** Switch the running UPS to maintenance bypass mode for power supply, as described in Section 4.1.5, or in standby mode when no power output is needed.

**Step 3:** Insert the USB flash disk into the USB interface of the monitoring board, and wait till the USBFig. become lit at the lower right corner of home page.

**Step 4:** Click the unlocking icon and enter the maintenance password.

**Step 5:** Enter the [Control]→[Firmware Upgrade] interface, click [Import Firmware], confirm and wait for successful import;

**Step 6:** Check whether the chip, the current version and the new firmware version are correct;

**Step 7:** Click the upgrade button on the right side of one of the chips to upgrade the corresponding firmware. During upgrading, wait till the corresponding chip is automatically restarted and displayed again, and upgrade the next chip till all chips are upgraded. The same program can be also broadcast for upgrades at the same time. Recommended firmware upgrade sequence: PFC-INV-BYP-ECU-MCU.

**Step 8:** After the firmware upgrade of the monitor, the monitor will be automatically restarted. It is required to manually exit the firmware upgrade page and all firmware information is displayed normally after entering again.

**Step 9:** Change the maintenance bypass power supply to the inverter power supply and power on the UPS inverter. Please refer to Step 2~Step 6 in Section 4.1.1 "Power On UPS".

#### Display HMI firmware upgrade

Operation procedure:

**Step 1:** Put the firmware package into the root directory of the U USB flash disk, such as USB drive : \ itepkg03.pkg.

**Step 2:** Insert the USB flash disk into the USB interface of the display.

**Step 3:** Click the reset button on the left side of the back cover to restart the display,

**Step 4:** Check whether there is a series of percentage burning progress on the display screen. If yes, wait till the burning is completed, and if no, fail to read the firmware or fail to recognize the USB flash disk. Please check whether the firmware program is correctly put into the USB flash disk or replace another USB flash disk and try again.



**Step 5:** When the burning is finished (that is, the "IMFO: Upgrade Finished" appear), pull out the USB flash disk, and click the reset button on the back panel of the display to restart the displayer.

**Step 6:** Enter the display page [System]→[About] to check whether the "display version" has been updated successfully.

## 4.2 Parallel operation

### 4.2.1 Start parallel system

<b>Attention</b>	
	<ul style="list-style-type: none"> <li>• Before on-site wiring and installation, confirm that all switches on the UPS are in the disconnected state.</li> <li>• Before starting , check whether the installation and wiring of the parallel system is perfect, all screws are locked, and the wiring is correct.</li> </ul>

**Step 1:** Install the parallel system.

For the installation method of the UPS parallel system, please refer to the relevant section of "50KVA-600KVA Installation Guide". Connect the power cable and the control cable. If the battery pack is independent, separate wiring is required.

**Step 2:** Confirm wiring

Use the multimeter to confirm that the wiring is in accordance with the requirements and the wiring is correct.

**Step 3:** Debug single UPS

After wiring is OK, confirm that the output switch of all UPS is in the disconnected state, and the output switch of the system is also in the disconnected state. After that, debug each single UPS in the parallel system one by one according to "4.1 Operation of Single UPS ". Record the output voltage of the single UPS, and confirm whether the single UPS is abnormal. After confirmation, power off the UPS, disconnect all input, output, battery, bypass switches of the single UPS.

**Step 4:** Check the output voltage of each single UPS

Afterdebugging and parameter confirmation of each UPS, restart the system and compare the output voltage of each UPS. Use the multimeter to confirm that the effective difference of the phase voltage of three phases between of any two UPS is less than 2V before the parallel operation. If the condition is not met, the UPS with large voltage deviation cannot be incorporated into the system, and its output voltage should be fine-adjusted. For the UPS with large voltage deviation, sampling and calibration should be carried out again to ensure that the effective difference of phase voltage of three phases with other UPS is less than 2V.

**Step 5:** Confirm software version

Ensure that all output, battery, bypass switches of the UPS are disconnected, and then connect all air switches of the UPS input. Verify the program version of the parallel UPS, enter the About interface of the system menu, verify the display version, monitor version, system version, rectifier version and inverter version to ensure that the program version of all parts is consistent.



Fig. 4-7 About interface

**Step 6:** Set parallel parameters (all UPS are powered off and disconnects the output)

1. Set the [Single Parallel] to [Parallel] in the basic parameter setting of the setting interface.
2. Set 1, 2, 3 and 4 in turn in the [cabinet number] of the setting interface of basic parameters. The parallel operation of at most 4 UPSs is supported, as shown in Fig.4-8.
3. Set the number of UPS in the parallel system in [number of system stands] of the basic parameter setting of the setting interface, as shown in Fig. 4-8.
4. Set one UPS of the parallel system as master and other UPS as the slave in the [rack master-slave setup] of the advanced parameter settings in the settings interface. The master-slave refers to the communication master-slave of the rack, that is to say, one UPS is the host for monitoring communication, and the other UPS are the slave for monitoring communication. The parameters of other UPS can be set on the communication host, and the slave automatically synchronizes the parameters of the master (for the independent battery pack, the battery parameters will not be synchronized), as shown in Fig. 4-8.

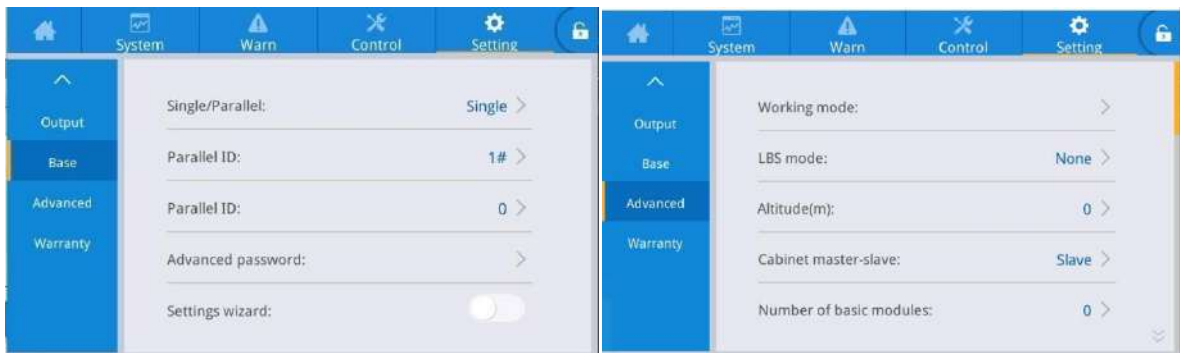

Fig. 4-8 Parallel parameter setting interface

5. Unified ON/ OFF enabling. If it is required to uniformly power on or off the UPS of the parallel system, set the unified ON/ OFF in the [Unified ON/ OFF] of the advanced parameter settings in the settings interface, as shown in Fig. Fig. 4-9

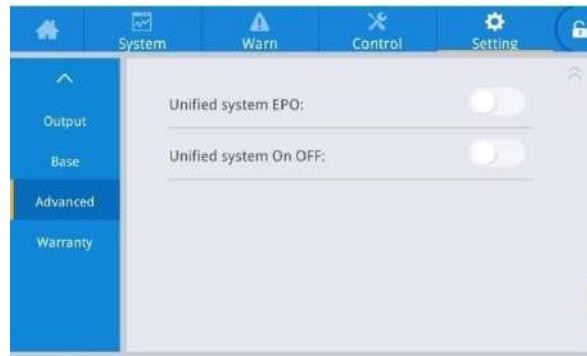

Fig. 4-9 Unified ON/ OFF setting interface

**Step 7:** Confirm parameters

The advanced parameters, the input parameters, output parameters, bypass parameters, battery parameters of the UPSs in the parallel system should be consistent in the setting interface (if shared, the form of battery pack is set to be consistent, and if independent, specific settings are made according to the battery configuration of each UPS). Refer to the function description of 3.2.6 Setting for the parameter setting.

**Step 8:** Check the bypass phase sequence (the output switch of each UPS and the output switch of the system are disconnected)

Switch each UPS to THE bypass mode and connect the output switch of UPS No. 1 (make sure the master switch of the load is disconnected, otherwise the power will be supplied to the load after the output switch of No. 1 UPS is connected). Maintain the output switches of other UPS in disconnection status. Attach the multimeter at the AC voltage range: one is connected to the front-end phase A of the output switch of the UPS No. 2, and another is connected to the back-end phase A of the output switch of the UPS No. 2, so as to measure the voltage difference before and after the output switch of the UPS No. 2. Measure the voltage of the phase B and C in same method. If the phase sequence is correct, the voltage difference of the phases is less than 5V; if the phase sequence is incorrect, the voltage difference of at least one phase is greater than 5V. If the bypass phase sequence of the UPS is correct, perform the next step. If the phase sequence of any UPS is incorrect, power off the system and check whether the bypass I/O cable of each UPS is correct. After confirmation, power off the UPS to disconnect the output.

**Step 9:** Confirm parallel signal

If the parallel communication line is not connected after setting to the parallel system, the alarm of "parallel communication cable failure" will be reported. Therefore, it is necessary to confirm that there is no the alarm of "parallel communication cable failure" in the UPS of the parallel system. If there is a fault, check whether the parallel communication cable is connected properly.

**Step 10:** Power on parallel system

Confirm that the system is only on the mains and bypass mode, and then connect the output air switches of all UPSs, and then directly click ON. The starting procedure of the parallel system is same with that of the single UPS.

**Step 11:** Add battery

Check and confirm on the monitor that each UPS has switched to the inverter mode. After the system output is normal, add the battery pack and connect the battery switch. In case of the

independent batteries, connect the battery switch of each UPS respectively. The "battery unconnected" alarm of each UPS disappears within 3min after connection. Make sure the battery is installed in properly.

**Step 12:** Switching test

Disconnect the main input switch and confirm that all UPSs are properly switched to the battery mode, which can be observed by the monitor.

Connect the input switch, and then manually shut down for switching to the bypass and check if all UPSs are normally switched to the bypass mode, which can be observed by the monitor.

**Step 13:** Connect the output switch of the system.

After the system is switched to the bypass, connect the output switch of the system while the bypass is loaded, and then the inverter mode is switched on normally. In this way, the startup process of the whole parallel system has been completed.

## 4.2.2 Power off parallel system

Operation procedure:

**Step 1:** Close all loads.

**Step 2:** If the unified ON/ OFF is enabled, the parallel can be powered off at the panel of any UPS. If the unified ON/ OFF is disabled, the parallel system is powered off by all panel of all UPSs.

**Step 3:** Orderly disconnect the output switch of the system, the output switch of the UPS, the battery switch, the bypass input switch, the main input switch 5min after completion of Step 2, so as to power off the whole system.

## 4.2.3 Emergency shutdown (EPO)

If unified EPO action is enabled, the whole parallel system is EPO in case of EPO of one UPS. If disabled, single UPS responds to the EPO.

## 4.2.4 Quit maintenance of single UPS

Operation procedure:

**Step 1:** When the single UPS fails, the output will automatically be disconnected and the parallel system exits. The system supplies the power by other UPS.

**Step 2:** Disconnect the output switch of the output distribution cabinet with failing UPS, or the external output distribution switch

**Step 3:** Disconnect the battery switch of the failing UPS (if there are multiple batteries, first disconnect the master switch between the battery pack and the UPS and then the switch of each battery) or the pre-stage distribution switch.

**Step 4:** Disconnect the main and bypass input switch of the output distribution cabinet with failing UPS, or the pre-stage distribution switch.

**Step 5:** Isolate the failing UPS from the system for maintenance.

## 4.2.5 Addition of single UPS after maintenance

Operation procedure:

**Step 1:** After maintenance of the single UPS, disconnect the parallel cable before starting, set the single UPS in the [single or parallel] of the basic parameter setting.

**Step 2:** After powering on, perform sampling calibration, and debug the single UPS. In this process, make sure to disconnect the output switch. See “4.1 Operation of Single UPS” for debugging of the single UPS.

**Step 3:** Confirm sequentially: check the output voltage of the single UPS, the software version, the parameter, and the bypass phase sequence according to Step 4 to Step 7 of 5.2.1, after confirmation, power off the system and disconnect the output.

**Step 4:** Reconnect the parallel cable, set the parallel parameters and confirm the parallel signal according to Step 9 and Step 10 of 4.2.1.

**Step 5:** Connect all switches of the added UPS, click the ON button on the panel to start and incorporate the UPS into the system.

## Chapter 5 UPS Maintenance

### 5.1 UPS Maintenance

#### 5.1.1 Monthly maintenance

- Check the operation of the UPS, including ambient temperature, humidity, input and output voltage, frequency, load type, load rate, various alarm information, etc.
- Check whether there is abnormal sound in the UPS. If yes, check the source of abnormal sound, focusing on the fan, input and output transformer (if not configured, omitted), the power unit and the bypass unit. If the reason cannot be analyzed, contact the customer service center in time.
- Check whether the input and output connection terminals of the UPS are firm, the connection cables are in good condition, aging or damaged. If damaged, analyze the cause of the damage and pay special attention to the prevention of rats.
- Check the UPS monitoring panel and confirm that all graphic display units on the monitoring panel are in normal operation status, that all operating parameters of the power supply are within the normal range, and there is no fault or alarm information in the displayed record.
- Clean the UPS that needs cleaning.
- Observe whether there is any change in the load of UPS, and periodically check and record the increase or decrease of load.
- Check and record the operating environment temperature and humidity of the UPS.
- Check whether the parameters of the UPS are set correctly.
- Fill in the UPS maintenance report form, and classify and treat abnormal situation and alarm.
- Export and analyze the alarm information from the system, and output the alarm analysis report.

#### 5.1.2 Quarterly maintenance

Repeat the monthly maintenance.

- Thoroughly clean the UPS, especially pay attention to removing the dust from the fan, the inlets and the outlets.
- Check the I/O cables and terminals for signs of aging, damage, burning and loosening. Reinforce all I/O terminals.
- If conditions permit, inspect the key components inside the UPS, mainly the following components:

Electrolytic capacitors: check for leakage, ejection and expansion.

Transformer and inductor: check for color change and layering, fall and other phenomena resulting from overheating.

Cables and flat cables: check the outer skin of the connecting cables for breakages, cracks and scratches, reinforce the terminals of all power cables, and check whether the cables between the boards are securely installed.

Fuses: Check that all fuses are in good condition and securely installed.

Printed circuit board: check the cleanliness of the printed circuit board and the integrity of the circuit, check whether there is color change resulting from overheating, the components on

the circuit board is in good condition, damaged and corroded.

- If input and output transformer is installed, check the transformer for color change and layering, fall and other phenomena resulting from overheating, to prevent the inter-turn short circuit, and check whether the connection terminal is firm, rusted or corroded.
- Use the multimeter and the clip-on ammeter to check the input, output, battery, load voltage and current meet the system requirements and the LCD display.

### 5.1.3 Yearly maintenance

Repeat the monthly maintenance and the quarterly maintenance.

- In order to prevent system failure resulting from the wear-out failure of some components, it is recommended that the critical components used in the UPS system be inspected periodically and replaced within their expected life .The life parameters and recommended replacement period of key components are shown in Table 5-1.

Table 5-1 Recommended replacement time of key components

Key component	Recommended replacement period	Recommended check period
Electrolytic capacitor	5-6 years	1 year
Fan	5 -6 years	1 year
Valve-controlled lead-acid batteries	3 -4 years	6 months

## 5.2 Battery maintenance

The following battery maintenance instructions are provided only for the reference during the maintenance of the conventional lead-acid battery. In the end, please refer to the battery maintenance instructions provided with the battery.

<b>Attention</b>	
	<ul style="list-style-type: none"> <li>• The battery should be replaced and maintained only by authorized maintenance personnel.</li> <li>• During the battery maintenance, it is required to use insulated tools (wrenches, etc.).</li> <li>• Disconnect all power supplies before connecting or disconnecting the terminals.</li> <li>• Do not smoke or use an open flame near the battery pack.</li> <li>• After the battery discharge, the battery should be fully charged within 24h, so as not to affect the battery life.</li> <li>• For the grid without power failure for a long time, the battery should be discharged every 3 ~ 6 months and then recharged, to extend the life of the battery.</li> <li>• Regularly measure the voltage of the battery pack and each cell to ensure the voltage balance of each cell. If the voltage of individual cell is too low, replace the corresponding cell.</li> </ul>

## Chapter 6 Failure Removal

The common failures are removed according to the Table 6-1.

Table 6-1 Removal of common failure

No.	Failure phenomenon	Analysis of causes	Removal method
1	Failure to start rectifier	Input AC voltage out of standard	Confirm whether the input distribution voltage is abnormal
		Abnormal input phase sequence of three phases of UPS	Check whether the input phase sequence of three phases of the UPS is normal.
		Power unit failure	Replace the power unit
2	Inverter failure and UPS switching to bypass power supply	Output overload or short circuit protection	Reduce the load or remove the short circuit failure of the load
		Overheating protection of UPS	Install an air conditioner or an ventilation facility to ensure the normal temperature
		Power unit failure	Replace the power unit
3	DC system failure causing unable to normally switch to the battery mode	Battery under-voltage or failure	Replace the battery
		Failure to connect the battery cable as required, or poor contact of wiring terminal, or air switch of battery disconnected	Remove the failure of the battery cable and ensure that the air switch is connected.
		Power unit failure	Replace the power unit
4	Operation of system in the bypass mode, and failure to switch to the inverter mode	Set to ECO mode	Set correct operating mode
		Bypass switching times reaching maximum value	Set suitable bypass switching times in the setting interface, or remove the failure in the control interface.
		Inverter failure	Remove the failure according to above 2.
5	Red instructor light of power unit becoming lit	Abnormal AC input and battery input	Check whether the input cable and other cables loosen or the power distribution is normal.
		Power unit failure	Replace the power unit

### Note

- Please consult the maintenance engineer for replacement and maintenance operations of the parts provided in Article 6 Troubleshooting and Appendix C.
- See the user manual for lithium battery for the alarm treatment of the lithium battery.



## Chapter 7 Technical Parameters

Model	200kW 300kW 400kW 500kW 600kW
Rated capacity	200kVA/200kW 300kVA/300kW 400kVA/400kW 500kVA/500kW 600kVA/600kW
<b>Physical characteristics</b>	
Wiring method	200kVA supports top incoming 300kVA supports top incoming and bottom incoming 400kVA, 500kVA and 600kVA support top incoming and bottom incoming
Product dimensions (H×W×D)	200kW: 2000mm×600mm×850mm 300kW: 2000mm×600mm×850mm 400kW: 2000mm×1200mm×850mm 500kW: 2000mm×1200mm×850mm 600kW: 2000mm×1400mm×850mm
Weight of the cabinet	200kW: 213kg in standard configuration 200kW: 233kg in full configuration 300kW: 242kg in standard configuration 300kW: 272kg in full configuration 400kW: 415kg in full configuration 500kW: 465kg in full configuration 600kW: 617kg in full configuration
Weight of power module	32kg
<b>Input index</b>	
Phase number of input	Three-phase five line (3Φ+N+PE)
Rated input voltage	380Vac/400Vac/415Vac
Variable range of input voltage	304 ~ 485Vac (not derated); 138 ~ 304Vac ( linear derating between 40% ~ 100% of load)
Variable range of input frequency	40 ~ 70Hz
Input power factor	≥0.99
Input current harmonics	≤3%
Voltage range of bypass input	-60% ~ +25% (settable)
battery voltage	Lead-acid battery: ± 240 Vdc (±180 ~ ± 276 Vdc settable), 40 pcs 12 V batteries (30, 32, 34, 36, 38, 40, 42, 44, 46 pcs settable) lithium battery: ±256VDC (±192VDC~±256VDC settable), 160 pcs 3.2V batteries (120、128、150、160 pcs settable)

<b>Output index</b>	
Phase number of output	Three-phase five line (3Φ+N+PE)
Rated output voltage	380Vac/400Vac/415Vac
Stabilization precision of output voltage	±1%
Output frequency precision	Mains mode: bypass input is traced in synchronous state; battery mode: 50Hz/60Hz±0.1%
Output power factor	1
Output waveform distortion factor	≤2%(linear load); ≤5%(non-linear load)
Peak factor of output current	3: 1
Overload capacity	For 105% < load ≤110%, switch to the bypass after 60min; for 110% <load ≤125%, switch to the bypass after 10min; for 125% < load ≤150% , switch to the bypass after 1min; for load > 150%, switch to the bypass after 0.2s
<b>System index</b>	
Maximum system efficiency	Online mode: 96%, ECO mode: 99%
Switching time	0 ms
Maximum parallel UPSs	4 sets
Protection function	Output short circuit protection, output overload protection, over temperature protection, battery low voltage protection, output under voltage protection, fan failure protection, etc
Communication interface	Standard: RS485, RS485/CAN(BMS), NET(with SNMP function), input/output dry contact and EPO; Optional: parallel module, LBS module, WiFi card, GPRS card, battery temperature sensor, EMD environment detector and SMS alarm.
Display	7inch color touch screen
<b>Operating environment</b>	
Operating temperature	0 ~ 40℃
Storage temperature	-25℃ ~ 55℃(excluding battery)
RH	0% ~ 95%(no condensation)
Altitude	Altitude ≤1000m. for more than 1000m, derated by 1% every increased 100m
Protection level	IP20
Noise (1m from the UPS)	≤65dB
<b>Design standard</b>	
Safety regulation	IEC 62040-1, GB7260.1-2008, GB7260.4-2008
EMC	IEC 62040-2, IEC61000-4-2(ESD), IEC61000-4-3(RS), IEC61000-4-4(EFT), IEC61000-4-5(Surge)

## Appendix 1 Display Menus

Level 1 menus	Level 2 menus	Level 3 menus	Level 4 menus		
Homepage					
System	Main circuit	Main voltage(V)			
		Main current (A)			
		Main frequency (Hz)			
	Bypass	Bypass voltage(V)			
		Bypass current (A)			
		Bypass frequency (Hz)			
	Battery (lead-acid)	Battery voltage(V)			
		Battery current (A)			
		Battery status			
		HOC (%)			
		Standby time (min)			
		Battery temperature(°C)			
		SOH (%)			
	Battery (lithium battery)	Whole system	Battery information of whole UPS		
			Battery voltage(V)		
			Battery current (A)		
			Battery status		
			Battery temperature(°C)		
			HOC (%)		
			SOH (%)		
			Maximum voltage of cell(mV)		
			Minimum voltage of cell (mV)		
			Maximum temperature of cell (°C)		
		Minimum temperature of cell (°C)			
		Lithium battery BMS	Battery pack n		Battery module n
			Battery voltage(V)		Maximum temperature of module (°C)
Battery current (A)			Minimum temperature of module (°C)		
maximum voltage of cell (mV)			Voltage of cell 1 (mV)		
minimum voltage of cell (mV)			voltage of cell 2 (mV)		

Level 1 menus	Level 2 menus	Level 3 menus	Level 4 menus	
			maximum temperature of cell (°C) .....	
			minimum temperature of cell (°C) voltage of cell 16 (mV)	
	Module (selection #)	Input voltage(V)		
		Input current (A)		
		Input frequency (Hz)		
		Active power of input (kW)		
		Apparent power of input (kVA)		
		Input power factor		
		Output voltage(V)		
		Output current (A)		
		Output frequency (Hz)		
		Output Active power(kW)		
		Apparent power of output (kVA)		
		Reactive power of output (kVa)		
		Output power factor		
		Operating mode of rectifier		
		Power supply mode of output		
		Charge voltage(V)		
		Charge current (A)		
		Output	Output voltage(V)	
	Output current (A)			
	Output frequency (Hz)			
	Load percentage (%)			
	Active power of output (kW)			
	Apparent power of output (kVA)			
	Statistics	Total operation time of bypass (min)		
		Total operation time of inverter (min)		
		Recent discharging time		
		Warranty expiration time of battery		

Level 1 menus	Level 2 menus	Level 3 menus	Level 4 menus		
	About	Warranty expiration time of UPS			
		Serial number			
		Cabinet number			
		Telephone			
		Manufacturer			
		Website			
		Display version			
		Monitor version			
		Bypass version			
		Version of rectifier 1			
Version of inverter 1					
Alarm	Current alarm				
	Failure record				
	Status record				
	Operation record				
Control	ON/ OFF	Power on/ off the system	On		
			Switching to bypass after shutdown	Disconnect output after shutdown	
		Manual switching to bypass	Open	Close	
	Maintenance	Power on/ off the module		Open UPM1	Close UPM1
				Open UPM2	Close UPM2
				Open UPM3	Close UPM3
				Open UPM4	Close UPM4
				Open UPM5	Close UPM5
				Open UPM6	Close UPM6
				Open UPM7	Close UPM7
				Open UPM8	Close UPM8
		Power on/ off the charger		Open charger 1	Close charger 1
				Open charger 2	Close charger 2
				Open charger 3	Close charger 3
				Open charger 4	Close charger 4
				Open charger 5	Close charger 5
				Open charger 6	Close charger 6
				Open charger 7	Close charger 7
Open charger 8	Close charger 8				
Even and floating charging control		Forced even charging	Forced floating charging		

Level 1 menus	Level 2 menus	Level 3 menus	Level 4 menus		
			Cancel forced even charging	Forced even charging by time	
		Self-check control	Self-check by time	Self-check by voltage	
			SOH calibration	Cancel self-check	
		Maintenance management	Restore factory setting	Mute	
			Clear records	Clear failure	
	USB guide	Export history record	Import LOGO		
	Firmware upgrade	Import firmware			
	Setting	Common setting	Language		
			Y-M-D		
			time		
Date format					
Luminance					
Automatic screen protection					
User password					
Remote control					
Communication setting		Serial port	Protocol	Baud rate	
			Address	Check	
		Network interface	IP allocation mode	IP address	
			Subnet mask	Gateway	
Dry contact setting		Input dry contact	DI_1	DI_2	
			DO_1	DO_2	
		Output dry contact	DO_3	DO_4	
			DO_5	DO_6	
Bypass parameter		ECO voltage range (%)			
		ECO frequency range (Hz)			
		Upper bypass voltage limit (%)			
		Lower bypass voltage limit (%)			
		Bypass frequency range (Hz)			
Input parameters		Starting delay of power unit in rack			
		Starting delay of power unit between racks			

Level 1 menus	Level 2 menus	Level 3 menus	Level 4 menus	
		Soft starting time of rectifier		
		Input current limit		
		Input current limit percentage (%)		
		Input adaptation		
	Battery parameters	Battery type		
		Battery capacity (Ah)		
		Number of cells		
		Number of battery pack		
		Battery pack form		
		Automatic battery self-check enabled		
		Starting time of automatic self-check		
		Ending time of automatic self-check		
		Consistent current even charging time of battery (h)		
		Longest discharge time (h)		
		Automatic battery self-check period (d)		
		Battery self-check time(h)		
		Battery voltage upon completion of self-check (V/cell)		
		Standby time alarm		
		Standby time alarm threshold (min)		
		SOC alarm		
		SOC alarm threshold (%)		
		SOH(%)		
	Charge current limit coefficient (C10)			
	Floating charge voltage of cell (V/cell)			

Level 1 menus	Level 2 menus	Level 3 menus	Level 4 menus	
		Even discharge voltage of cell (V/cell)		
		Contact voltage even charging time of battery (h)		
		High temperature alarm point of battery (°C)		
		Low temperature alarm point of battery (°C)		
		Even charging protection interval (d)		
		Timed even charging interval (d)		
		Temperature compensation of floating charge voltage		
		Temperature compensation coefficient of floating charge voltage (mV/°C-cell)		
		Discharge current 0.1C EOD(V/cell)		
		Discharge current 1.0C EOD(V/cell)		
		Battery unlocking time (min)		
		Cell EOD voltage alarm increase (V)		
		Coefficient for switching to floating charge current (C10)		
		SOC for switching to even charging (%)		
		Output parameters	Output frequency trace rate (Hz/s)	
	Bypass switching times			
	Output voltage(V)			
	Output frequency (Hz)			
	Fine tuning of output voltage (V)			
	Self-ageing output current percentage (%)			



Level 1 menus	Level 2 menus	Level 3 menus	Level 4 menus	
	Basic parameters	Single or parallel		
		Cabinet number		
		Maintenance password		
		Quick setting		
		Language setting limit		
	Advanced parameters	Operating mode		
		LBS mode		
		System rack number		
		Module cycle sleep period (d)		
		Rack mast-salve setting		
		Number of basic module in rack		
		Number of redundant module in rack		
		Smart parallel operation sleep mode		
		charger sleep		
		charger sleep time (d)		
		altitude (m)		
	Warranty expiration setting	Warranty expiration of battery	Installation time	Warranty period (year)
			Warranty expiration time	
		Warranty expiration of UPS	Installation time	Warranty period (year)
			Warranty expiration time	

## Appendix 2 List of Alarms

Alarm code	Alarm name	Cause	Suggestion for repairing
99	Abnormal BMS communication	Communication failure between UPS and	Check that the communication cables are normal and reconnect the communication cable
100-102	Input over-voltage	Too high input voltage	Check the main input voltage
103-104	Input under-voltage	Too low input voltage	Check the main input voltage
106	Input over-frequency	Abnormal input frequency	Check the main input frequency
107	input under-frequency	Abnormal input frequency	Check the main input frequency
108	Reverse phase sequence of input	Reverse phase sequence of input	Check the main input cable
109	Unbalanceinput voltage	Unbalanceinput voltage	Check the main input voltage
110	Unbalance input current	Unbalance input current	Replace the power unit or module
124	Phase loss of input	Phase loss of input	Check the main input cable
125	Null line of input not connected	Null line of input not connected	Check whether the unbalanced load is too large
126	Input overload	Input overload	Check whether the load is too high
200	Over-voltage of positive bus	Voltage of positive bus exceeding set voltage	In case of too high main input or bypass input voltage, after recovery of the voltage, first "remove failure", restart the UPS. If the too voltage persists, replace the power unit or module
201	Over-voltage of negative bus	Voltage of negative bus exceeding set voltage	
202	Bus over-voltage	Bus voltage exceeding set voltage	
203	Under -voltage of positive bus	Voltage of positive bus below set voltage	Replace the power unit or module
204	Under-voltage of negative bus	Voltage of negative bus below set voltage	Replace the power unit or module
206	Unbalance voltage of positive and negative buses	Voltage difference of positive and negative buses exceeding set voltage	Replace the power unit or module
207	Over-voltage failure of bus hardware	Bus voltage exceeding the set hardware voltage	Replace the power unit or module
210	Reach the bus over-voltage times	Bus over-voltage times exceeding set value	Replace the power unit or module
211	Life of bus capacitor below 1 year	Life of bus capacitor below 1 year	Replace the power unit or module

Alarm code	Alarm name	Cause	Suggestion for repairing
212	Instantaneous under-voltage of positive bus	Voltage of positive bus below set voltage	Replace the power unit or module
213	Instantaneous under-voltage of negative bus	Voltage of negative bus below set voltage	Replace the power unit or module
218	Bus short circuit	Bus short circuit	Check bus connection or replace the power unit or module
219	Reach soft starting times of bus	Soft starting times of bus exceeding setvalue	Replace the power unit or module
300	Battery over-temperature	Battery temperature reaching the battery over-temperature alarm point	Check whether the battery cable is loose, battery voltage or current meets the parameter specified in the user manual of the battery. Strengthen the ventilation of the battery room.
301	Battery self-check failed	Battery self-check failed	Check whether the number of cells is se properly Replace the power unit or module
302	Battery over-voltage	Battery voltage exceeding battery over-voltage protection point	Check whether the number of cells is se properly Replace the power unit or module
303	Battery DOD under-voltage	Battery DOD under-voltage	Check whether the main voltage is abnormal for long time Check for the overload
304	Battery EOD under-voltage	Battery voltage reaching EOD voltage for continuous discharge	Check the mains and charge the battery in time,
305/309	Battery over-charge	Charger failure	Replace the power unit or module
322	Charge current of battery	Charger failure	Check the number of the cells is actual number of the cells, otherwise replace the power unit or module
323	Discharge current of battery	Discharge current of battery	Check the weak battery is connected with the overload, and clear the failure after reduction of the load. If the failure persists, replace the power unit or module.
324	Voltage upon completion of battery discharge.	Battery voltage reaching EOD voltage for continuous discharge	Check the mains and charge the battery in time

Alarm code	Alarm name	Cause	Suggestion for repairing
325	Battery discharge time ended	Continuous battery discharge time exceeding discharge protection time	Check the mains and charge the battery in time
330	Standby time pre-alarm	Battery standby time failing to reach the expected standby time	Check the mains and charge the battery in time Check the battery capacity
331	HOC pre-alarm	Battery HOC failing reach expected HOC	Check the mains and charge the battery in time, Check the battery capacity
332	Battery maintenance alarm	Interval from last battery maintenance exceeding maintenance period	Reset the battery maintenance alarm after the battery maintenance
336	Battery fuse failure	Battery fuse failure	Check whether battery fuse is damaged
338	Abnormal battery connection	Battery connected reversely	Check the battery polarity and reinstall the battery
339		Battery note connected	Check whether the interface voltage of the battery is normal, the battery is installed properly, and the battery fuse is normal.
357	Battery low-temperature	Low ambient temperature of battery room	Increase the ambient temperature of the battery room.
320	Charger over-voltage	Charger over-voltage	Check whether the number of the cells is set properly, and clear the failure if yes. If the failure persists, replace the power unit or module.
321	Charger under-voltage	Charger under-voltage	
322	Charger over-current	Charger over-current	Replace the power unit or module
335	Soft starting failed of charger	Soft starting failed of charger	Replace the power unit or module
346	Short circuit of charger switch	Short circuit of charger switch	Replace the power unit or module
347	Open circuit of charger switch	Open circuit of charger switch	Check whether the difference between the charge voltage and the battery voltage is allowable error range, and if no, recalculate the charge voltage and the battery voltage. If the failure persists, replace the power unit or module
348	Charger over-temperature	Charger over-temperature	Check the fan and turn off the charger.

Alarm code	Alarm name	Cause	Suggestion for repairing
349-350	Over-voltage of charger hardware	Over-voltage of charger hardware	Check whether the number of the cells is set properly, and clear the failure if yes. If the failure persists, replace the power unit or module.
351-352	Wave current limit alarm of charger hardware	Wave current limit alarm of charger hardware	
353-354	Wave current limit failure of charger hardware	Wave current limit failure of charger hardware	
363	Level 1 charging protection of lithium battery	Trigger Level 1 charging protection of lithium battery	Check whether the lithium battery, and the lithium battery is properly set. If the failure persists, replace the damaged lithium battery pack or module.
364	Level 1 discharging protection of lithium battery	Trigger Level 1 discharging protection of lithium battery	Check whether the lithium battery, and the lithium battery is properly set. If the failure persists, replace the damaged lithium battery pack or module.
365	Level 2 charging protection of lithium battery	Trigger Level 2 charging protection of lithium battery	Check whether the lithium battery, and the lithium battery is properly set. If the failure persists, replace the damaged lithium battery pack or module.
366	Level 2 discharging protection of lithium battery	Trigger Level 2 discharging protection of lithium battery	Check whether the lithium battery, and the lithium battery is properly set. If the failure persists, replace the damaged lithium battery pack or module.
369	Lithium battery charge alarm	Trigger lithium battery charge alarm	Check whether the lithium battery, and the lithium battery is properly set. If the failure persists, replace the damaged lithium battery pack or module.
370	Lithium battery discharge alarm	Trigger lithium battery discharge alarm	Check whether the lithium battery, and the lithium battery is properly set. If the failure persists, replace the damaged lithium battery pack or module.
400	Soft starting failed of input AC	Soft starting failed of input AC	Replace the power unit or module
401	Soft starting failed of Battery DC	Soft starting failed of Battery DC	Replace the power unit or module
402	Soft starting failed of BUS DC/DC	Soft starting failed of BUS DC/DC	Replace the power unit or module
403	Input phase lock failed	Input phase lock failed	Replace the power unit or module
404	Frequent switching between mains and battery	Frequent switching between mains and battery	Check the quality of the grid, and if necessary, replace the power unit or module

Alarm code	Alarm name	Cause	Suggestion for repairing
405	Reach soft starting times of rectifier	Soft starting times of rectifier exceeding set value	Replace the power unit or module
406-411	Wave current limit alarm of rectifier hardware	Wave current limit alarm of rectifier hardware	Check for the overload or instantaneous load
412-417	Over-current failure of rectifier hardware	Over-current failure of rectifier hardware	Check for the overload, otherwise replace the power unit or module
418-423	Rectifier over-current	Rectifier over-current	Replace the power unit or module
424-429	wave current limit failure of rectifier hardware	wave current limit failure of rectifier hardware	Check for the overload, otherwise replace the power unit or module
430	Soft starting failed of bus hardware	Soft starting failed of bus hardware	Replace the power unit or module
447	battery mode over-current of rectifier	battery mode over-current of rectifier	Replace the power unit or module
448	Mains mode over-current of rectifier	Mains mode over-current of rectifier	Replace the power unit or module
500-505	Over-temperature of Rectifier IGBT module	Over-temperature of Rectifier IGBT module	Check whether the fan is normal, or the ambient temperature is too high, and the UPS operates with full load for long time.
506	E2PROM read-write failed	E2PROM read-write failed	Replace the power unit or module
507	Communication failure of rectifier DSP and monitor	Communication failure of rectifier DSP and monitor	Check whether the communication cables are properly connected. Replace the power unit or module or the monitor unit.
508	Communication failure of rectifier DSP and CPLD	Communication failure of rectifier DSP and CPLD	Replace the power unit or module
509-511	Fan failure	Fan failure	Check the fan for locked-rotor. If yes, recover the fan to normal operation, otherwise replace the power unit.
512	Abnormal auxiliary power supply of rectifier	Abnormal auxiliary power supply of rectifier	Manually clear Replace the power unit or module
515	rectifier contactor failure	rectifier contactor failure	Replace the power unit or module

Alarm code	Alarm name	Cause	Suggestion for repairing
516	Abnormal version of CPLD software	Abnormal version of CPLD software	Load the software
517	Abnormal version of DSP software	Abnormal version of DSP software	
518	No matching between software version and hardware version of rectifier	No matching between software version and hardware version of rectifier	
520	Rectifier emergency shutdown	Rectifier emergency shutdown	Check the status of the emergency shutdown button. Remove the failure
525	SPI communication failure between rectifier and inverter	SPI communication failure between rectifier and inverter	Replace the power unit or module
600-602	Bypass over-voltage	Bypass over-voltage	Check the input voltage or cables of the bypass Check the voltage system set on the monitor and the upper and lower bypass voltage limits are reasonable.
603-605	Bypass under-voltage	Bypass under-voltage	Check the input voltage or cables of the bypass Check the voltage system set on the monitor and the upper and lower bypass voltage limits are reasonable.
607	Bypass over-frequency	Bypass over-frequency	Check the input frequency of the bypass Check the rated frequency and the frequency setting range
608	Bypass under frequency	Bypass under frequency	Check the input frequency of the bypass Check the rated frequency and the frequency setting range
617	Reverse phase sequence of bypass	Reverse phase sequence of bypass	Check the bypass input cables of three phase
619-621	Open circuit failure of bypass SCR	Open circuit failure of bypass SCR	Replace the power unit or module
622-624	Short circuit failure of bypass SCR	Short circuit failure of bypass SCR	
625-626	Auxiliary power supply failure of bypass	Auxiliary power supply failure of bypass	Manually remove Replace the bypass unit
627	Bypass overload 125%	Bypass load 125% time reached	Check whether the load is too large Check whether the module is derated

Alarm code	Alarm name	Cause	Suggestion for repairing
629	Bypass overload 150%	Bypass load 150% time reached	for the fan failure. Replace the power unit or module if no problem is found in above inspection.
647	Bypass overload 200%	Bypass load 200% time reached	
655	Bypass overload alarm	Bypass load exceed full load alarm	Reduce the load
631	Communication failure of bypass DSP and monitor	Communication failure of bypass DSP and monitor	Replace the bypass unit or the monitor module
633	Abnormal software version of bypass DSP	Abnormal software version of bypass DSP	Load the software
635	NO matching between bypass software version and hardware version	NO matching between bypass software version and hardware version	
636	Bypass E2PROM operation failure	Bypass E2PROM operation failure	Replay the bypass unit or module
644-646	Bypass over-temperature	Bypass over-temperature	Check the bypass output for over-current. If yes, reduce the load Check whether the air duct of the fan is blocked. If yes, remove the barrier Check the fan for locked-rotor. If yes, recover the fan to normal operation, otherwise replace the power unit.
656-658	ECO bypass over-voltage	ECO bypass over-voltage	Check the input voltage or cables of the bypass Check the voltage system set on the monitor and the upper and lower bypass voltage limits are reasonable.
659-661	ECO bypass voltage under-voltage	ECO bypass voltage under-voltage	Check the input voltage or cables of the bypass Check the voltage system set on the monitor and the upper and lower bypass voltage limits are reasonable.
662	ECO bypass over-frequency	ECO bypass over-frequency	Check the input frequency of the bypass Check the rated frequency and the frequency setting range are reasonable



Alarm code	Alarm name	Cause	Suggestion for repairing
663	ECO bypass under-frequency	ECO bypass under-frequency	Check the input frequency of the bypass Check the rated frequency and the frequency setting range are reasonable
707	Output overload 105%	Reach output overload 105%	Check for the overload Check the module for derating resulting from the fan failure. If no, replace the power unit or module
708	Output overload 110%	Reach output overload 110%	
709	Output overload 125%	Reach output overload 125%	
710	Output overload 150%	Reach output overload 150%	
721	Output overload alarm	Output overload alarm	Reduce the load
800-802	Inverter over-voltage	Inverter over-voltage	Replace the power unit or module
803-804	Inverter under-voltage	Inverter under-voltage	Replace the power unit or module
806	Unbalance inverter voltage	Unbalance inverter voltage	Replace the power unit or module
807-809	Too high DC component (R S T )	Too high DC component (R S T )	Check for special load (for example, half-wave load). if no, replace the power unit or module
901	Phase lock failure of inverter	Phase lock failure of inverter	Replace the bypass unit or module
902	Frequent switching between bypass and inverter	Frequent switching between bypass and inverter	Check the grid of the bypass, automatically remove the failure, otherwise replace the power unit or module
903	Reach soft starting times of inverter	Reach soft starting times of inverter	Replace the power unit or module
904	Abnormal even current of parallel system	Abnormal even current of parallel system	Replace the power unit or module
905	Self-check failure of inverter	Self-check failure of inverter	Replace the power unit or module

Alarm code	Alarm name	Cause	Suggestion for repairing
1000-1005	Over-temperature of inverter fan	Temperature of inverter fan exceeding the set value	Check the bypass output for over-current. If yes, reduce the load. Check whether the air duct of the fan is blocked, and if yes, remove the barrier Check the fan for the locked-rotor. If yes, recover the fan and otherwise replace the power unit
1006-1013	Over-current failure of inverter hardware	Over-current failure of inverter hardware	Check for the overload, larger instantaneous non-linear load. if no, replace the power unit or module
1022-1024	Output short circuit of inverter	Output short circuit of inverter	Check the output end for the short circuit. If yes, replace the power unit, and if no, check the cables of the load
1026	Abnormal of inverter power supply	Abnormal of inverter power supply	Manually remove Replace the power unit or module
1027	Inverter contactor failure	Inverter contactor failure	Replace the power unit or module
1028	Communication failure between inverter DSP and monitor	Communication failure between inverter DSP and monitor	Check CCB communication cable for correct connection, or replace the power unit or the monitor unit.
1029	Communication failure between inverter DSP and system board	Communication failure between inverter DSP and system board	Check CCB communication cable for correct connection, or replace the power unit or module
1030	Abnormal version of inverter CPLD software	Abnormal version of inverter CPLD software	Load the software
1031	Abnormal version of inverter DSP software	Abnormal version of inverter DSP software	
1032	No matching between inverter software version and hardware version	No matching between inverter software version and hardware version	
1033	Inverter E2PROM operation failure	Inverter E2PROM operation failure	Replace the power unit or module
1034	Communication failure between inverter DSP and CPLD	Communication failure between inverter DSP and CPLD	Replace the power unit or module

Alarm code	Alarm name	Cause	Suggestion for repairing
1036-1038	Inverter fuse failure	Inverter fuse failure	Check whether the inverter fuse is damaged
1039	Emergency shutdown of inverter	Emergency shutdown of inverter	Check the status of the emergency shutdown button Remove the failure
1014-1019	Wavecurrent limit alarm of inverter hardware	Wavecurrent limit alarm of inverter hardware	Check for the overload, larger instantaneous non-linear load. if no, replace the power unit or module
1048-1053	Wavecurrent limit failure of inverter hardware	Wavecurrent limit failure of inverter hardware	Check for the overload, larger instantaneous non-linear load. if no, replace the power unit or module
1056	Inverter module overload 105%	Reach inverter module overload 105% time	Check for the overload Check the module for derating resulting from the fan failure. If no, replace the power unit or module
1057	Inverter module overload 110%	Inverter module overload 110% time	
1058	Inverter module overload 125%	Reach inverter module overload 125% time	
1059	Inverter module overload 150%	Reach inverter module overload 150% time	
1072	Inverter module overload alarm	Inverter load exceeding full-load power alarm	Reduce the load
1068	Abnormal synchronous square wave	Abnormal synchronous square wave	Check the synchronous square wave signal cable for correct connection Replace the power unit or module
1069	Open circuit failure of inverter relay	Open circuit failure of inverter relay	Replace the power unit or module
1070	Short circuit failure of inverter relay	Short circuit failure of inverter relay	
1080	Load impact	Load impact	Check for larger instantaneous non-linear load Check the output load for the short circuit If the load is normal replace the power unit or module
1100	Abnormal CAN communication between system board and inverter module	Abnormal CAN communication between system board and inverter module	Check the communication cable of the system and the inverter module
1101	Same address of multiple inverters	Same address of multiple inverters	Check the address of the inverter modules

Alarm code	Alarm name	Cause	Suggestion for repairing
1109	System self-check failure	System self-check failure	Replace the power unit or module
1111	Switching to bypass for load impact	Switching to bypass for load impact	Check for larger instantaneous non-linear load Check the output load for the short circuit If the load is normal replace the power unit or module
1200	Abnormal CAN communication between system boards	Abnormal CAN communication between system boards	Check the communication cables of the system boards.
1201	System overload 105%	Reach system overload 105% time	Check for the overload Check the module for derating resulting from the fan failure. If no, replace the power unit or module
1202	System overload 110%	Reach system overload 110% time	
1203	System overload 125%	Reach system overload 125% time	
1204	System overload 150%	Reach system overload 150% time	
1205	System overload alarm	System load exceeding the design full load of the system	Reduce the load
1317	Request of adjacent to switch to bypass	Request of adjacent to switch to bypass	Check the cause for switching the adjacent UPS to the bypass
1329	Repeated switching and locking bypass	Repeated switching and locking bypass	Check for frequent addition of instantaneous load Automatically remove after locking delay
1330	Repeated switching and locking inverter	Repeated switching and locking inverter	Check for frequent addition of instantaneous load Automatically remove after locking delay

## Appendix 3 Abbreviation

A		
AC	Alternating Current	
AWG	American Wire Gauge	
C		
CAN	Controller Area Network	
CE	Conformite Europeenne	
D		
D.G.	Diesel Generator	
DC	Direct Current	
DSP	Digital Signal Processing	
E		
ECM	Energy Control Module	
ECO	Economy Control Operation	
EMC	Electro Magnetic Compatibility	
EOD	End Of Discharge	
EPO	Emergency Power Off	
H		
HMI	Human Machine Interface	
I		
IDC	Internet Data Center	
IEC	International Electrotechnical Commission	
IP	InternetProtocol	
L		
LBS	Load Bus Sync	
LCD	LiquidCrystalDisplay	
LED	Light Emitting Diode	
P		
PCB	PrintedCircuitBoard	
PDC	PowerDistributionCabinet	
PE	ProtectiveEarthing	
R		

RS485	RecommendStandard 485	
<b>S</b>		
SNMP	Simple Network Management Protocol	
STS	StaticTransferSwitch	
SN	Serial Number	
<b>T</b>		
THDi	Total Harmonic Distortion Rate Of Current	
THDu	Total Harmonic Distortion Rate Of Voltage	
<b>U</b>		
UI	UserInterface	
UPS	UninterruptiblePowerSystem	
<b>V</b>		
VRLA	Valve RegulatedLeadAcid	